

Bodengruppe (Unterseite)	Spannung	Baugruppe	Ausgabe	gültig ab Seriennummer
Bottom (Lower elevation)	Voltage	Group	Edition	Application from Serial.No.
	3 N AC 400V 50Hz	10	10.1.1	C11C93065001

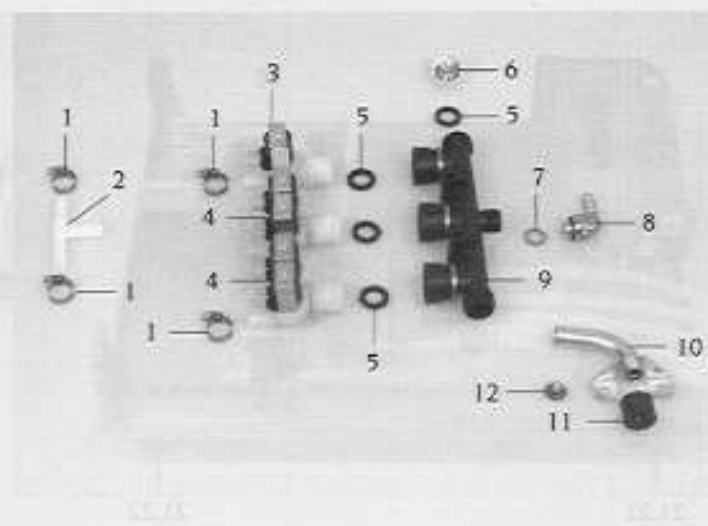

Pos.	St.	Ersatz-Nr.	Bezeichnung	Description
Pos.	Pcs.	Sp. Part No.		
-	-	2067.0050	Silikonschlauch 1m	Silicone hose 1m
1	8	2066.0205	Schlauchschele 12-18mm	Hose clamp 12-18mm
2	1	2062.0302	T-Stück TS10	T-piece TS10
3	1	3002.0331	Einfachmagnetventil kpl. 220-240V/50Hz	Single solenoid valve unit 220-240V/50Hz
4	2	3002.0330	Doppelmagnetventil kpl. 220-240V/50Hz	Double solenoid valve unit 220-240V/50Hz
5	4	5110.1024	Dichtung für Verschraubung G 3/4"	Gasket for G3/4" threaded joint
6	1	2062.0314	Geradeverschraubung G 3/4	Straight threaded joint G 3/4
7	1	2062.0208	Winkelverschraubung G1/2"x10"	Elbow screw point G1/2"x10"
8	1	5012.0539	Dichtung für Verschraubung G 1/2"	Gasket for G1/2" threaded joint
9	1	8664.1007	Wasserverteiler	Water distribution unit
10	1	8455.1008	Tropfwannenverbinder	Connection for drip container
11	1	2022.0204	Verbindungsstülpe f. Gerätetropfwanne	Connection grommet for drop container
12	2	1106.0801	Sechskant-Combi-Mutter M 6	Hexagonal combination nut M6
13	1	2112.1010	Schlauch d 15x3x520 mm	Hose d 15x3x520 mm
14	1	2067.0125	Silikonschlauch 880 mm	Silicone hose 880 mm
15	1	2067.0164	Silikonschlauch 650 mm	Silicone hose 650 mm
16	1	2067.0166	Silikonschlauch 1750 mm	Silicone hose 1750 mm
17	1	2067.0159	Silikonschlauch 900 mm	Silicone hose 900 mm
18	1	2067.0141	Silikonschlauch 1065 mm	Silicone hose 1065 mm
19	1	2067.0161	Silikonschlauch 1450 mm	Silicone hose 1450 mm
20	1	2067.0164	Silikonschlauch 650 mm	Silicone hose 650 mm
21	4	2039.0112	Fußoberteil	Upper part of pedestal
22	4	2039.0113	Fußunterteil	Lower part of pedestal

Bodengruppe (Oberseite) Bottom (Top elevation)	Spannung Voltage	Baugruppe Group	Baugruppe Group	gültig ab Seriennummer Application from Serial.No.
	3 N AC 400V 50Hz	9	9.1.1	C11C93065001

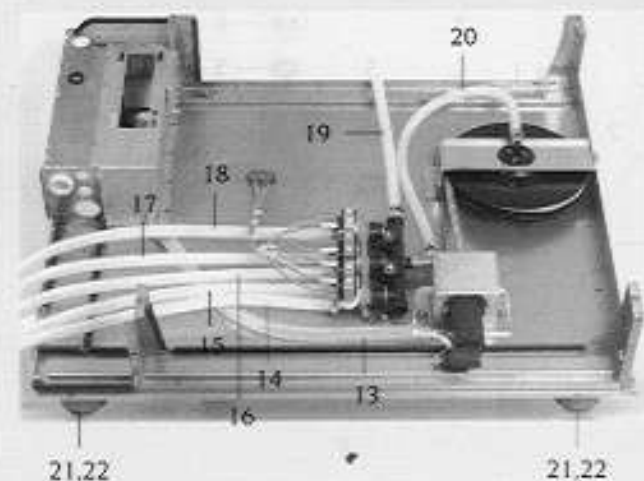
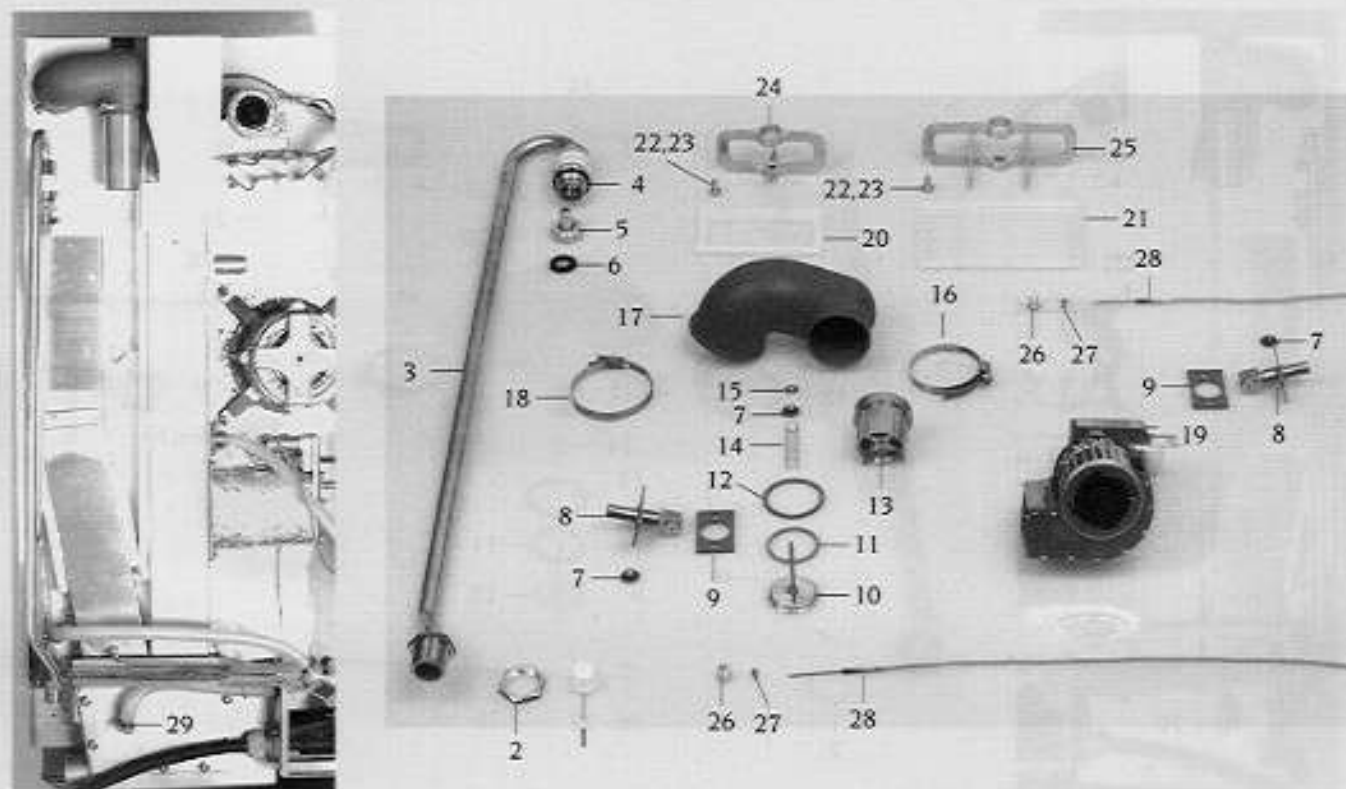

Pos.	St.	Ersatz-Nr.	Bezeichnung	Description
Pos.	Pcs.	Sp. Part No.		
-	1	8450.1001	Sicherheitsventil kpl.	Safety valve unit
1	1	1900.0202	Wasserfilter grob	Water filter coarse
2	2	2062.0313	Kontermutter G 3/4	Lock-nut G 3/4
3	1	2910.1032	Rohranschluß	Tube connection
4	1	2069.0102	Armaturenkombination	Valve unit with non-return valve
5	1	2062.0314	Geradeverschraubung G 3/4	Straight threaded joint G 3/4
6	1	5110.1024	Dichtung für Verschraubung G 3/4*	Gasket for G3/4" threaded joint
7	5	1105.0122	Sechskant-Combi-Mutter M 5	Hexagonal combination nut M5
8	2	8666.1021	Ablöschdüse kpl. 1.7l/min.	Quenching nozzle unit 1.7 l/min.
9	2	5110.1031	Dichtung Ablöschdüse	Gasket for quenching nozzle
10	1	2064.1001	Unterdruckstempel f. Sicherheitsventil	Vacuum/depression ram for safety valve
11	1	2064.1003	Unterdruckdichtung f. Sicherheitsventil	Vacuum/depression gasket for safety valve
12	1	2064.1004	Überdruckgewichtdichtung f. Sicherheitsventil	Overpressure weight gasket for safety valve
13	1	2064.1000	Überdruckgewicht f. Sicherheitsventil	Overpressure weight for safety valve
14	1	2064.1002	Unterdruckfeder f. Sicherheitsventil	Vacuum/depression spring for safety valve
15	1	1107.0100	Schnellbefestiger 4,0 mm	Quick fastener 4.0 mm
16	1	2066.0504	Schlauchselle 40-60mm	Hose clamp 40-60mm
17	1	5012.0570	Haube f. Sicherheitsventil	Cap for safety valve
18	1	2066.0300	Schlauchselle 50-70mm	Hose clamp 50-70mm
19	1	3101.1003	Querstromlüfter	Cooling fan
20	1	5110.1026	Dichtung klein für Ablöschkanal/ Gerätedeckel	Small gasket for quenching channel/top cover
21	1	5110.1017	Dichtung groß für Ablöschkanal/ Gerätedeckel	Large gasket for quenching channel/top cover
22	2	1008.0751	Sechskantschraube M5x25	Hexagonal screw M 5x25
23	2	1315.0260	Unterlegscheibe A5,3	Washer A5,3
24	1	2940.1017	Fixierung klein für Gerätedeckel	Small fixing for top cover
25	1	2940.1015	Fixierung groß für Gerätedeckel	Large fixing for top cover
26	2	3014.0163	Stopfbuchsnippel für Thermoelement	Gasket sleeve with nipple
27	2	3014.0162	Dichtkegel für Thermoelement	Sealing cone for thermo element
28	2	3014.0161	Mantelthermoelement	Sheath thermo element
29	1	8666.1049	Ablöschdüse Ablaufkasten	Quenching nozzle for outlet box

ClimaPlus	Spannung	Baugruppe	Ausgabe	gültig ab Seriennummer
ClimaPlus	Voltage	Group	Edition	Application from Serial.No.
	3 N AC 400V 50Hz	3	3.1.1	C11C93065001

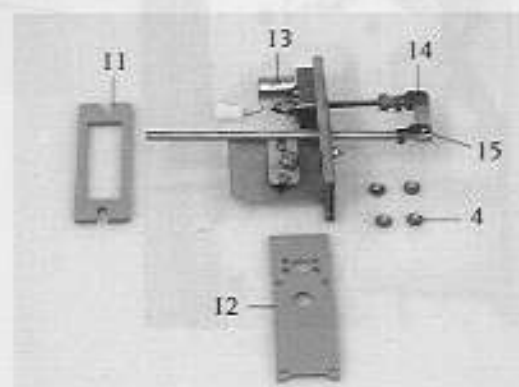
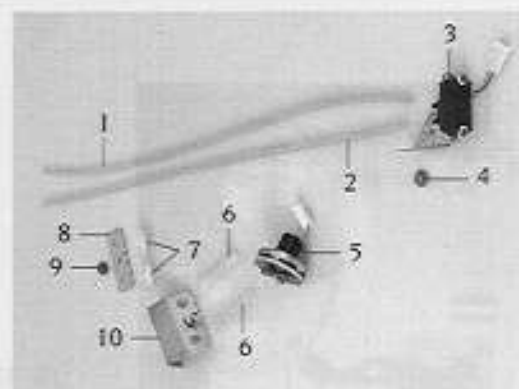
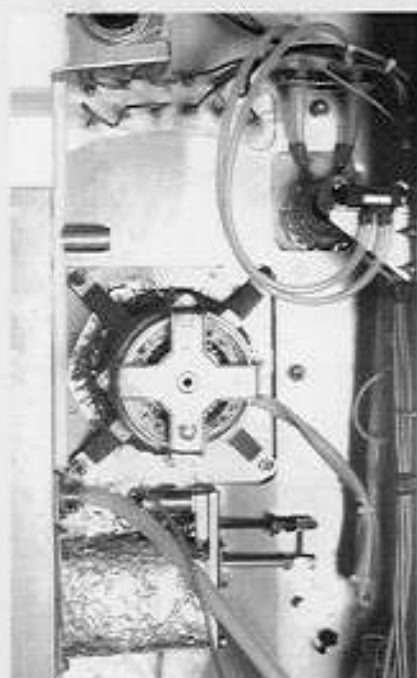

Pos.	St.	Ersatz.Nr.	Bezeichnung	Description
Pos.	Pcs.	Sp. Part No.		
-	1	3040.2602	Platine kpl. f. Feuchtmotor	PCB cpl. for sensor motor
-	1	8680.1008	Kondensatfilter vormontiert (Pos. 6-10)	Pre-fitted condenser filter (pos. 6-10)
1	1	2112.1012	Druckschlauch blau d 3x2,5x500mm	Pressure hose blue d 3x2,5x500mm
2	1	2112.1013	Druckschlauch rot d 3x2,5x500mm	Pressure hose red d 3x2,5x500mm
3	1	8680.1018	Drucksensor kpl. 164PC	Pressure sensor unit 164PC
4	5	1105.0122	Sechskant-Combi-Mutter M 5	Hexagonal combination nut M5
5	1	8680.1006	Motor f. Feuchtmessung kpl.	Sensor motor
6	2	2112.1014	Druckschlauch 8x2x80	Pressure hose 8x2x80
-	2	2112.1015	Druckschlauch 5x1,5x10	Pressure hose 5x1,5x10
7	2	1900.0201	Kondensatfilter	Condensation filter
8	1	2760.1067	Filterhalter oben	Holder top for condensation filter
9	1	1106.0801	Sechskant-Combi-Mutter M6	Hexagonal combination nut M6
10	1	8680.1016	Filterhalter unten	Holder below condensation filter
11	1	5110.1011	Dichtung Ablöschkanal Stellschieber	Gasket for quenching channel set slider
12	1	5110.1014	Dichtung Verschlussflansch	Gasket for closure flange
13	1	3101.1001	Stellmotor f. Schieber	Servo motor for slider
14	1	2016.0402	Federklappbolzen 6x12mm	Cap bolt with locking spring 6x12 mm
15	1	2016.0403	Federklappbolzen 4x16mm	Cap bolt with locking spring 4x16 mm
16	1	3014.0162	Dichtkegel für Thermoelement	Sealing cone for thermo element
17	1	3014.0163	Stopfbuchsnippel für Thermoelement	Gasket sleeve with nipple
18	1	3014.0161	Mantelthermoelement	Sheath thermo element

ClimaPlus	Spannung	Baugruppe	Ausgabe	gültig ab Seriennummer
ClimaPlus	Voltage	Group	Edition	Applicable from Serial.No.
	3 N AC 400V 50Hz	3	3.1.2	C11C95057001

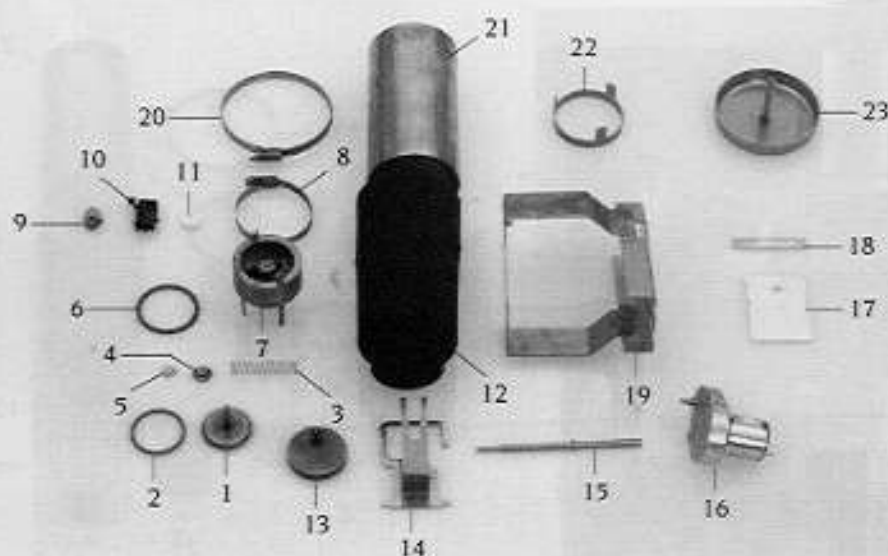
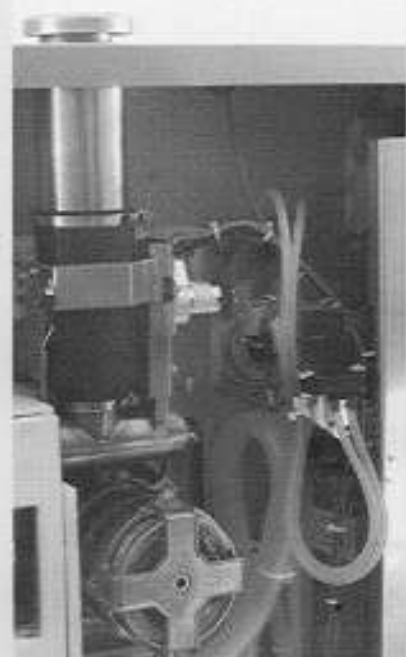

Pos.	St.	Ersatz.Nr.	Bezeichnung	Description
Pos.	Pcs.	Sp. Part No.		
-	1	3040.2602	Platine kpl. f. Feuchtmotor	PCB complete for sensor motor
-	1	8450.1003	Be- und Entlüftung kpl.	Humidity control cpl.
-	1	8450.1200	Sicherheitsventil kpl.	Safety valve unit
1	1	2064.1200	Unterdruckstempel	Vacuum/depression ram
2	1	2064.1003	Unterdruckdichtung	Vacuum/depression gasket
3	1	2064.1002	Unterdruckfeder	Vacuum/depression spring f
4	5	1105.0122	Sechskant-Combi-Mutter M 5	Hexagonal combination nut M5
5	1	1107.0100	Schnellbefestiger 4,0 mm	Quick fastener 4.0 mm
6	2	2064.1004	Überdruckgewichtdichtung	Overpressure weight gasket
7	2	2940.1200	Überdruckgewicht	Overpressure weight
8	1	2066.0504	Schlauchschele 40-60mm	Hose clamp 40-60mm
9	1	2940.1201	Nocke	Cam
-	1	1004.0900	Gewindestift M3x8	Allen set screw M3x8
10	1	3016.0101	Mikroschalter	Micro switch humidity control
-	2	1003.0033	Zylinderschraube M3x16	Slotted head screw M3x16
-	2	1304.0150	Unterlegscheibe A3,2	Washer A3,2
11	1	2016.1002	Teflonbuchse	Teflon bearing
12	1	2118.1200	Manschette Be- und Entlüftung	Form rubber humidity control
13	1	2940.1202	Exzenter	Excenter humidity control
-	1	1251.1000	Sicherungsring 5mm	Guard ring 5mm
14	1	8680.1201	Bügel für Überdruckgewicht	Holding bracket safety valve
-	2	1107.0101	Schnellbefestiger d5,0mm	Quick fastener d5.0mm
15	1	2120.1200	Antriebswelle	Drive shaft humidity control
16	1	3101.1007	Belüftungsstellmotor 24V	Humidity control motor 24V
-	2	1003.0020	Flachkopfschraube M3x10	Pan head screw M3x10
-	2	1304.0150	Unterlegscheibe A3,2	Washer A3,2
17	1	5010.1200	Dämmplatte A2x50x65	Insulating slab A2x50x65
18	1	2930.1200	Gewindeplatte	Mounting bracket humidity control motor
19	1	8680.1200	Halter für Belüftungsstellmotor	Bracket for humidity control motor
20	1	2066.0505	Schlauchschele 70-90mm	Hose clamp 70-90mm
21	1	8455.1208	Glockenhalter	Vent cover bracket
22	1	2910.1206	Abstandshalter für Glocke	Distance holder for vent cover
23	1	8455.1209	Glocke	Vent cover

Bedienblende Control Panel	Spannung Voltage 3 N AC 400V 50Hz	Baugruppe Group 1	Baugruppe Group 1.1.1	gültig ab Seriennummer Application from Serial.No. C11C93065001
-------------------------------	---	-------------------------	-----------------------------	---

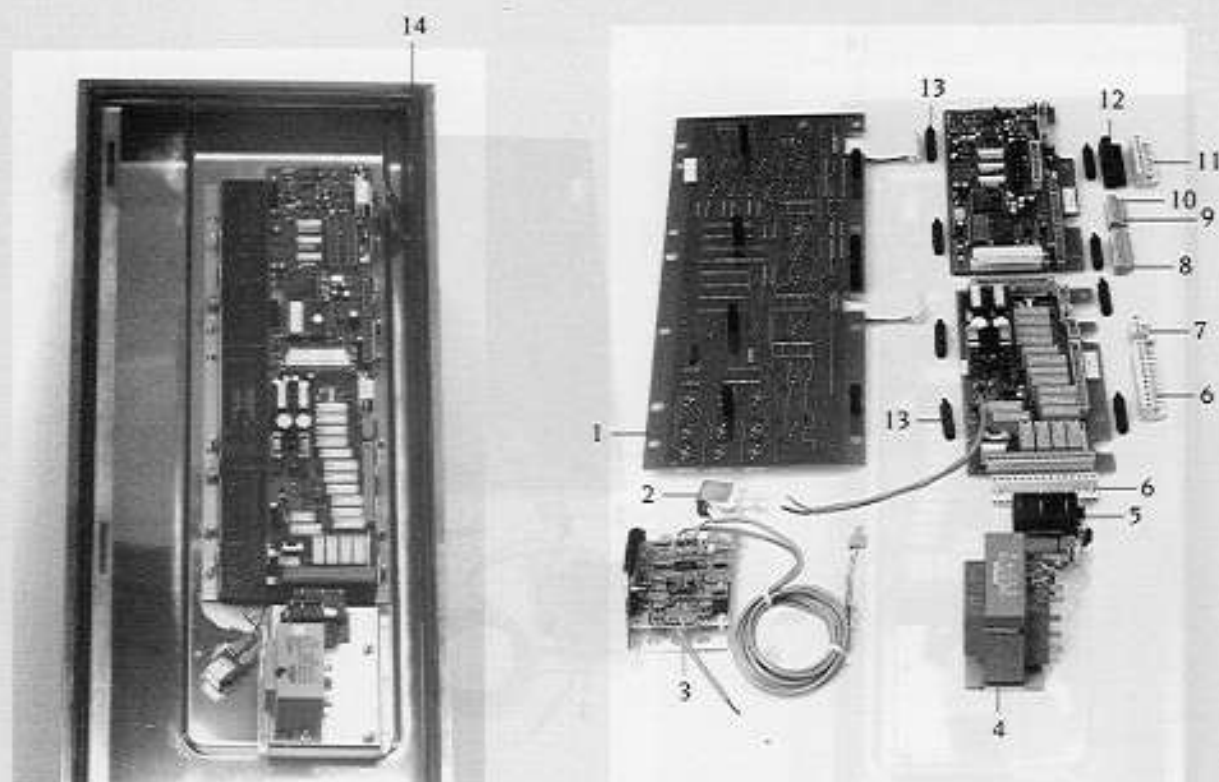

Pos.	St.	Ersatz.Nr.	Bezeichnung	Description
Pos.	Pcs.	Sp. Part No.		
-	-	8461.1001	Bedienblende kpl.	Control panel
1	1	3040.2040	Regel- und Steuerelektronik kpl.	PCB complete
-	9	2039.0326	Silikonfeder	Silicone spacer
2	1	3006.0103	Alarmsumner	Alarm buzzer
3	1	3040.2602	Platine für Feuchtmotor	PCB for sensor motor
4	1	3037.0203	Steuertrafo 35VA	Transformer 35VA
5	1	3028.0601	Kleinschütz E 3250, 24V	Mini contactor E 3250, 24V
6	2	3040.0230	Steckerleiste BL 15	Multipoint connector BL15
7	1	3040.0194	Steckerleiste BL 4	Multipoint connector BL4
8	1	3040.0227	Steckerleiste BL 12	Multipoint connector BL12
9	1	3040.0228	Steckerleiste BL 9	Multipoint connector BL9
10	1	3040.0229	Steckerleiste BL 3	Multipoint connector BL3
11	1	3040.0232	Steckerleiste grau BL 10	Multipoint connector grey BL10
12	1	3040.0231	Steckerleiste schwarz BL 10	Multipoint connector black BL10
13	16	1403.0169	Abstandsbolzen M4x25	Spacing bolt M4x25
-	1	3016.1408	Türkontaktschalter	Door contact switch
14	1	5105.1012	Dichtungsrahmen f. Bedienblende	Gasket frame for panel

Bedienblende Control panel	Spannung Voltage 3 N AC 400V 50Hz	Baugruppe Group 1	Ausgabe Edition 1.1.2	gültig ab Seriennummer Applicable from Serial.No. C11C95057001
--------------------------------------	--	--------------------------------	------------------------------------	---

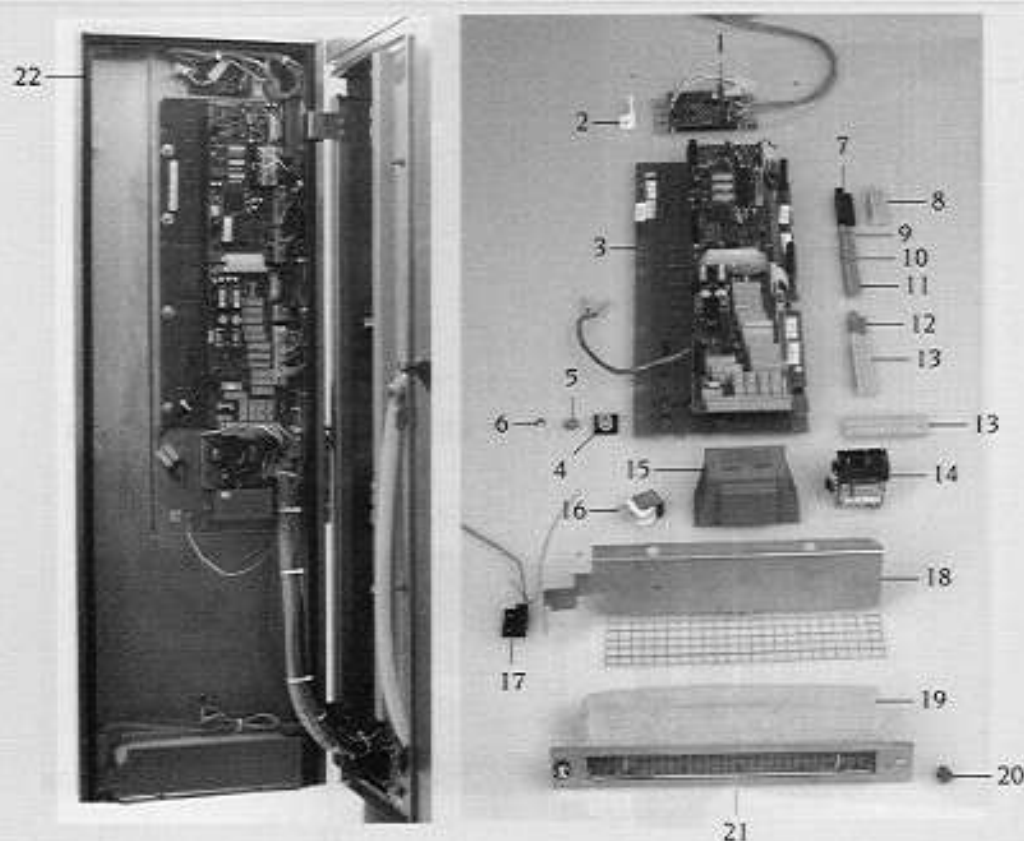

Pos.	St.	Ersatz.Nr.	Bezeichnung	Description
Pos.	Pcs.	Sp. Part No.		
-	1	8461.1201	Bedienblende kpl.	Control panel cpl.
-	1	8720.1208	Bedienblende mit Folie	Control panel with overlay
-	1	8464.1200	Filterträger kpl.	Air inlet filter cpl.
1	1	3040.2602	Platine kpl. f. Feuchtmotor	PCB complete for sensor motor
2	1	2020.0400	Befestigungselement kurz	Cabel holder short
3	1	3040.2040	Regel- und Steuerelektronik	PCB complete
4	9	2039.0326	Silikonfeder	Silicone spacer
5	9	1305.0160	Unterlegscheibe A5,3	Washer A5,3
6	9	1105.0124	Sechskantmutter selbstsichernd M5	Hexagonal nut self-locking M5
7	1	3040.0231	Steckerleiste schwarz BL 10	Multipoint connector black BL 10
8	1	3040.0232	Steckerleiste grau BL 10	Multipoint connector grey BL 10
9	1	3040.0229	Steckerleiste BL 3	Multipoint connector BL 3
10	1	3040.0228	Steckerleiste BL 9	Multipoint connector BL 9
11	1	3040.0227	Steckerleiste BL 12	Multipoint connector BL 12
12	1	3040.0194	Steckerleiste BL 4	Multipoint connector BL 4
13	2	3040.0230	Steckerleiste BL 15	Multipoint connector BL 15
14	1	3028.0601	Kleinschütz E 3250, 24V	Mini contactor E 3250, 24V
15	1	3037.0203	Steuertrafo 35VA	Transformer 35VA
16	1	3006.0103	Alarmsummer	Alarm buzzer
17	1	3016.1408	Türkontaktschalter	Door contact switch
-	1	3016.1409	Magnet rund Tischgeräte	Magnet round table models
18	1	2712.1200	Türkontaktträger	Door contact mounting bracket
-	2	1103.0600	Sprennmutter 2mm	Expansion nut 2mm for self-tapping screw
-	2	1304.0150	Unterlegscheibe A3,2	Washer A3,2
-	2	1003.2160	Sechskant Blechschraube A2,9x9,5	Hex self-tapping screw A2,9x9,5
19	1	5214.1208	Filtermatte	Filter gaze
20	2	2043.0205	Verschlußbolzen	Locking pin
21	1	8464.1201	Filterträger	Air inlet filter
22	1	5105.1012	Dichtungsrahmen f. Bedienblende	Gasket frame for panel

Gerätetür Door	Spannung Voltage	Baugruppe Group	Baugruppe Group	gültig ab Seriennummer Application from Serial.No.
	3 N AC 400V 50Hz	8	8.1.1	C11C93065001

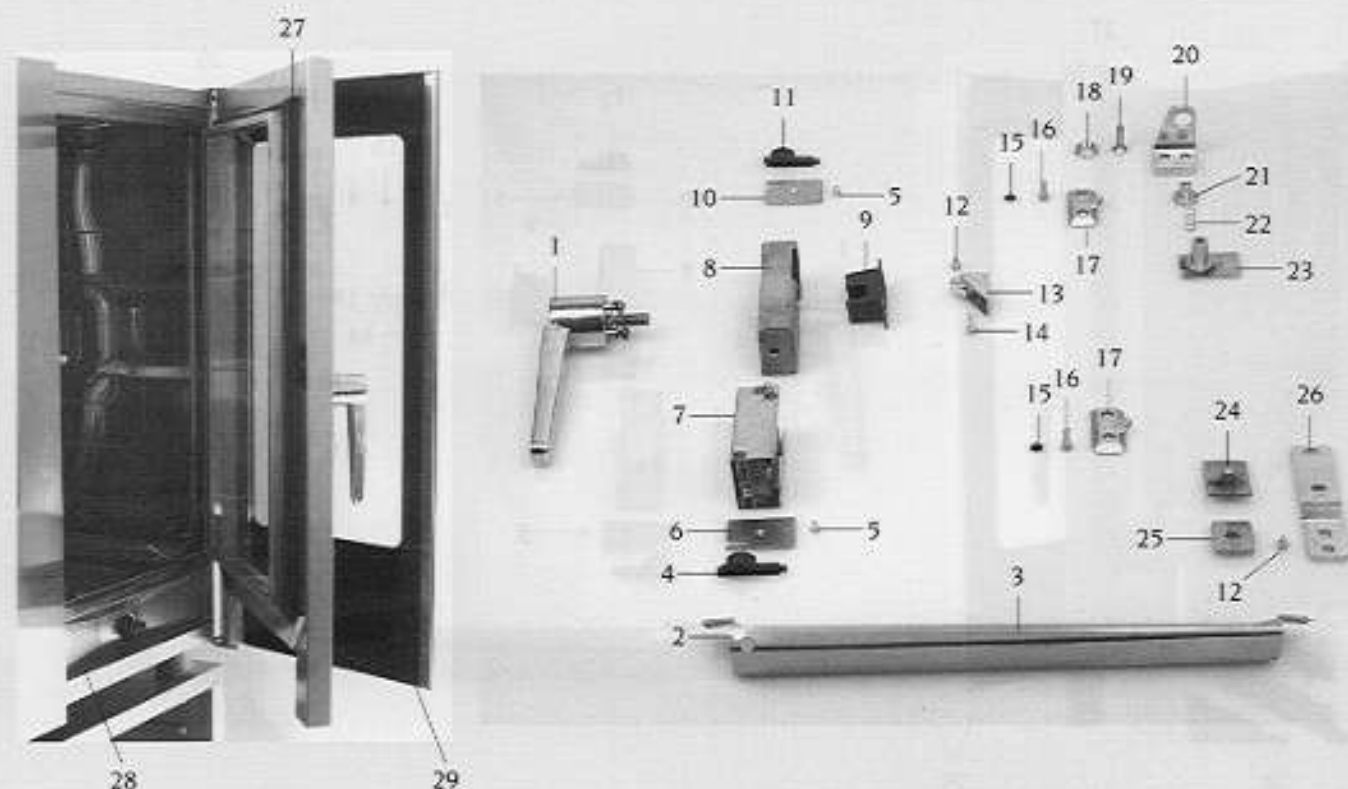

Pos. St. Pos. Pcs.	Ersatz-Nr. Sp. Part No.	Bezeichnung	Description
- 1	8470.1003	Türe kpl.	Door unit
1 1	2016.1500	Türgriff kpl.	Door-handle unit
2 1	2039.0321	Gleitkuppe f. Tropfwanne	Plastic knob for door drip collector
3 1	8474.1014	Türtropfwanne kpl.	Door drip collector
4 1	2043.0102	Riegel unten f. Außentüre	Lower bolt for external door
- 2	2001.0112	Druckfeder d 0,5x23 mm	Compression spring d 0.5x23 mm
5 4	1004.0430	Senkschraube m. Schlitz M4x16	Slotted countersunk-head screw M4x16
6 1	2760.1050	Deckel unten Verschlußseitig	Lower lid on the side of the seal
7 1	8474.1008	Einschub kpl. f. Türe unten	Plug-in unit for bottom door
8 1	8474.1001	Verschluß kpl. f. Türgriff	Lock for door-handle
9 1	2039.0319	Abdeckung f. Schloß Innenseite	Internal lock cover
10 1	2760.1049	Deckel oben Verschlußseitig	Upper lid on the side of the seal
11 1	2043.0101	Riegel oben f. Außentüre	Upper bolt for external door
12 3	1005.2000	Sperrzahnschraube M 5x8	Interlocking tooth screw M 5x8
13 1	2016.0610	Fangloben kpl. Tischgeräte	Door catch unit
14 2	1005.2100	Sperrzahnschraube M 5x16	Interlocking tooth screw M5x16
15 5	2039.0309	Abdeckkappe f. Türe	Cap for door
16 4	1006.7601	Innensechskantschraube M 6x16	Allen screw M6x16
17 2	2060.1600	Lagerbock f. Außenscheibe	Bearing pedestal for external window/disc
18 1	2120.1010	Unterlegscheibe 25x4mm	Washer 25x4mm
19 1	1008.1960	Senkschraube m. Innensechskant M 8x30	Countersunk-head screw M8x30
20 1	2930.1002	Türhaltewinkel oben	Door holding angle top
21 1	2120.1009	Türhaltebolzen oben	Door holding bolt top
22 1	2001.0111	Druckfeder f. Türhaltebolzen	Compression spring for door holding pin
23 1	8474.1009	Deckel oben kpl. drehpunktseitig	Upper lid unit at side of the pivot
24 1	8474.1010	Deckel unten kpl. drehpunktseitig	Lower lid unit at side of the pivot
25 1	2930.1001	Rastteller	Locking plate bottom
26 1	2930.1000	Türkonsole unten	Lower door console
27 1	5105.1004	Dichtungsrahmen f. Türe/Garraum	Gasket frame for door/interior cabinet
28 1	8455.1007	Gerätetropfwanne	Drip collector
29 1	8474.1016	Glasscheibe außen kpl.	External glass pane unit
- 1	5105.1003	Dichtungsrahmen für Glasscheibe	Gasket frame for internal glass panel

Elektromontageplatte Electrical Installation	Spannung Voltage	Baugruppe Group	Ausgabe Edition	gültig ab Seriennummer Application from Serial.No.
	3 N AC 400V 50Hz	2	2.1.1	C11C93065001

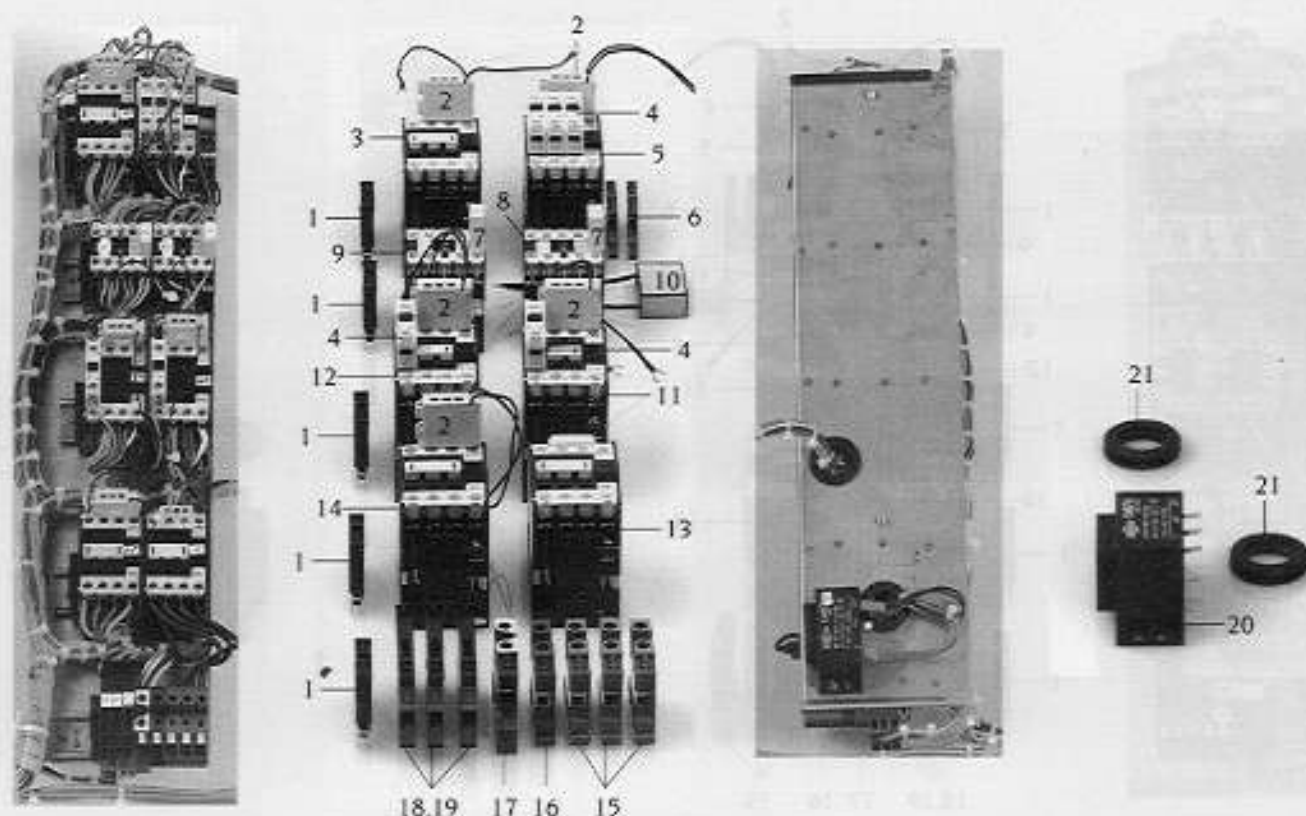

Pos.	St.	Ersatz.Nr.	Bezeichnung	Description
Pos.	Pcs.	Sp. Part No.		
1	5	4001.1203	Endklammer für Tragschiene	End terminal for supporting rail
2	5	3035.0515	RC-Glied	RC-Link
3	1	3028.0507	Schütz LS 04.01 220-240V 50/60Hz	Contacteur LS 04.01 220-240V 50/60Hz
4	5	3028.0153	Hilfskontaktschalter HS 17.10	Auxiliary contact switch HS 17.10
5	1	3028.0507	Schütz LS 04.01 220-240V 50/60Hz	Contacteur LS 04.01 220-240V 50/60Hz
6	2	4001.1216	Reihen клемме 4mm ² grau	Terminal 4mm ² grey
7	2	3035.0517	RC-Glied	RC-Link
8	1	3028.0504	Schütz LS 05.01 230V 50/60Hz	Contacteur LS 05.01 230V 50/60Hz
9	1	3028.0504	Schütz LS 05.01 230V 50/60Hz	Contacteur LS 05.01 230V 50/60Hz
10	1	3102.1000	RC-Glied	RC-Link
11	1	3028.0507	Schütz LS 04.01 220-240V 50/60Hz	Contacteur LS 04.01 220-240V 50/60Hz
12	1	3028.0507	Schütz LS 04.01 220-240V 50/60Hz	Contacteur LS 04.01 220-240V 50/60Hz
13	1	3028.0506	Schütz LS 04.10 220-240V 50/60Hz	Contacteur LS 04.10 220-240V 50/60Hz
14	1	3028.0517	Schütz LS 17-4.00 200-240V 50/60 Hz	Contacteur LS 17-4.00 200-240V 50/60 Hz
15	3	4001.1202	Reihen клемме 16mm ² grau	Terminal 16mm ² grey
16	1	4001.1250	Reihen клемме 16mm ² blau	Terminal 16mm ² blue
17	1	4001.1210	Erdungsreihen клемме 16mm ² gelb/grün	Earth terminal 16mm ² yellow/green
18	3	4001.1247	Sicherungsklemme	Fuse holder
19	3	4001.0218	Feinsicherung 6,3A	Fuse 6.3A
20	1	3037.0205	Halogenrafo 10VA	Halogen transformer 10VA
21	2	2022.0105	Durchführungsstülpe d 26mm	Lead-in grommet d 26 mm

Elektromontageplatte Electrical installation	Spannung Voltage 3 N AC 400V 50Hz	Baugruppe Group 2	Ausgabe Edition 2.1.2	gültig ab Seriennummer Applicable from Serial.No. C11C95057001
--	---	-------------------------	-----------------------------	--

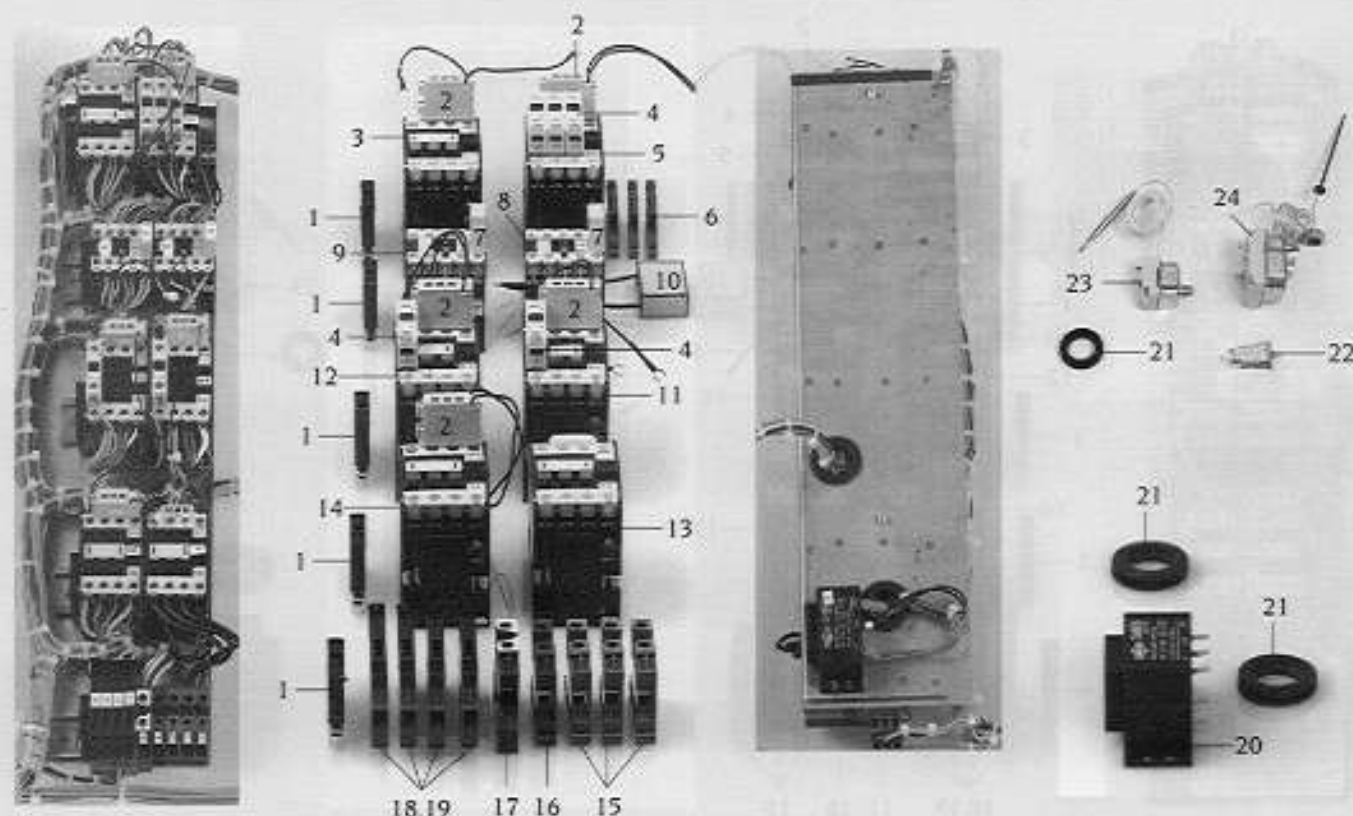

Pos. St. Pos. Pcs.	Ersatz-Nr. Sp. Part No.	Bezeichnung	Description
- 1	8950.1200	Montageplatte 3 N AC 400V 50Hz	Contact assembly 3 N AC 400V 50Hz
1 5	4001.1203	Endklammer für Tragschiene	End plate for supporting rail
2 5	3035.0521	RC-Glied	RC-Link
3 1	3028.0507	Schütz LS 04.01 200-240V 50/60Hz	Contact LS 04.01 200-240V 50/60Hz
4 5	3028.0153	Hilfskontaktschalter HS 17.10	Auxiliary contact switch HS 17.10
5 1	3028.0507	Schütz LS 04.01 200-240V 50/60Hz	Contact LS 04.01 200-240V 50/60Hz
6 3	4001.1216	Reihenklammer 4mm² grau	Terminal 4mm² grey
7 2	3035.0517	RC-Glied	RC-Link
8 1	3028.0504	Schütz LS 05.01 230V 50/60Hz	Contact LS 05.01 230V 50/60Hz
9 1	3028.0504	Schütz LS 05.01 230V 50/60Hz	Contact LS 05.01 230V 50/60Hz
10 1	3102.1000	Wechselspannungskondensator 1.5 µF,250V	Capacitor 1.5 µF,250V AC
11 1	3028.0509	Schütz LS 17.01 200-240V 50/60Hz	Contact LS 17.01 200-240V 50/60Hz
12 1	3028.0509	Schütz LS 17.01 200-240V 50/60Hz	Contact LS 17.01 200-240V 50/60Hz
13 1	3028.0508	Schütz LS 17.10 200-240V 50/60Hz	Contact LS 17.10 200-240V 50/60Hz
14 1	3028.0517	Schütz LS 17.4 200-240V 50/60 Hz	Contact LS 17.4 200-240V 50/60 Hz
15 3	4001.1202	Reihenklammer 16mm² grau	Terminal 16mm² grey
16 1	4001.1250	Reihenklammer 16mm² blau	Terminal 16mm² blue
17 1	4001.1210	Erdungsreihenklammer 16mm² gelb/grün	Earth terminal 16mm² yellow/green
18 4	4001.1247	Sicherungsklemme	Safety terminal
19 4	4001.0218	Feinsicherung 6,3A	Fuse 6,3A
20 1	3037.0205	Halogenrafo 10VA	Halogen transformer 10VA
21 2	2022.0105	Durchführungsstelle d 26mm	Lead-in grommet d 26 mm
22 1	3014.0400	Überstromauslöser einpolig f. Motorschutz	Current limiter for motor protection
23 1	3014.0300	Trockengehschutz 125°C	Dry up protector 125°C
- 1	3014.0302	Sechskantmutter M10	Hex nut M10
24 1	3014.0322	Sicherheitstemperaturbegrenzer 360°C	Safety temperature limiter 360°C

Handbrause Hand Shower	Spannung Voltage	Baugruppe Group	Baugruppe Group	gültig ab Seriennummer Application from Serial.No.
	3 N AC 400V 50Hz	11	11.1.1	C11C93065001

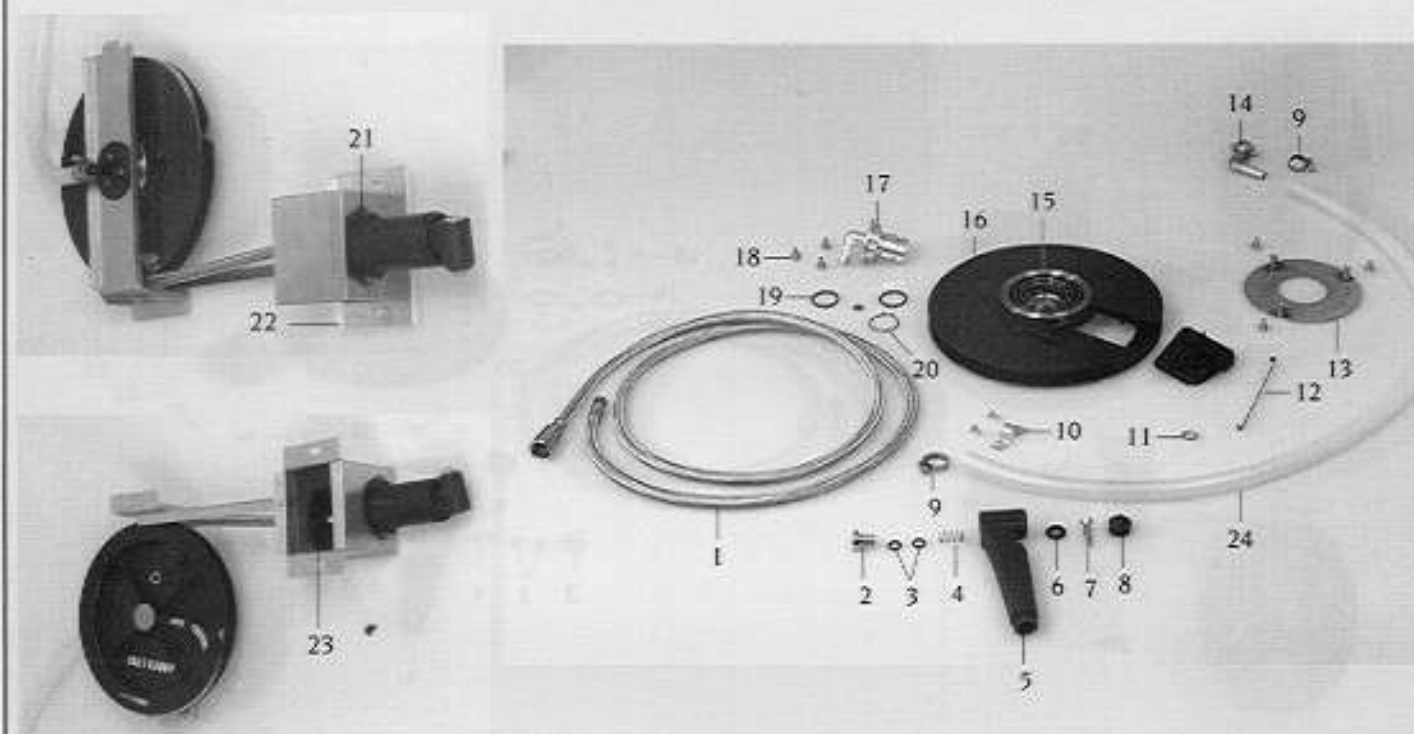

Pos.	St.	Ersatz.Nr.	Bezeichnung	Description
Pos.	Pcs.	Sp. Part No.		
-	1	8655.2000	Schlauchroller kpl.	Hand shower roll guide
1	1	2067.0605	Brauseschlauch 1500 mm	Shower hose 1500 mm
	2	2060.0228	O-Ring	O-ring
2	1	2060.1001	Druckknopf für Handbrause	Push-button for hand shower
3	2	5012.0559	O-Ring f. Schlauchbrause d 7x2,5mm	O-ring d 7x2,5mm
4	1	2001.0110	Druckfeder f. Schlauchbrause	Compression spring
5	1	2060.1000	Handbrause kpl. (inkl.Pos 2-8)	Hand shower (incl.Pos 2-8)
6	1	5012.0558	O-Ring f. Schlauchbrause d 8x5mm	O-ring d 8x5mm
7	1	2060.1003	Steilkegelstift Handbrause	Steep taper pin for hand shower
8	1	2060.1002	Düse f. Handbrause	Jet for hand shower
9	2	2066.0205	Schlauchscheile 12-18mm	Hose clamp 12-18mm
10	1	2760.1159	Befestigungsschelle	Hose clamp
-	2	1003.0231	Kerbschraube 3,9x13 mm	Slotted screw 3.9 x 13 mm
11	1	2001.0203	Federmutter d 8mm	Spring nut d 8 mm
12	1	2001.0202	Bügel Feder f. Schlauchroller	Return spring for hose roll guide
13	1	8655.2005	Sicherungsscheibe	Locking plate
14	1	2062.0208	Winkelverschraubung G1/2"x10	Elbow screw point G1/2"x10
-	1	5012.0539	Dichtung für Verschraubung G 1/2"	Gasket for G1/2" threaded joint
15	1	2001.0201	Spiralfeder f. Schlauchroller	Spiral coiled spring for hose roll guide
16	1	2060.0150	Schlauchrad für Handbrause	Retractable wheel for hand shower
17	1	2060.0157	Achse f. Schlauchroller	Axle for hose roll
18	3	1005.2000	Sperrzahnschraube M5x8	Interlocking tooth screw M5x8
19	1	8000.0081	Satz O-Ringe	Set O-ring
20	1	1250.0103	Sicherungsring 28mm	Snap ring 28mm
21	1	2060.1005	Handbrauseaufnahme	Hand shower intake
22	1	5110.1020	Dichtung f. Spritzschutz Handbrause	Gasket for splash guard hand shower
23	2	5110.1021	Dichtscheibe f. Spritzschutz Handbrause	Seal ring for splash guard hand shower
24	1	2067.0164	Silikonschlauch 650mm	Silicone hose 650mm

Handbrause Hand shower	Spannung Voltage	Baugruppe Group	Ausgabe Edition	gültig ab Seriennummer Applicable from Serial.No.
	3 N AC 400V 50Hz	11	11.1.2	C11C95057001

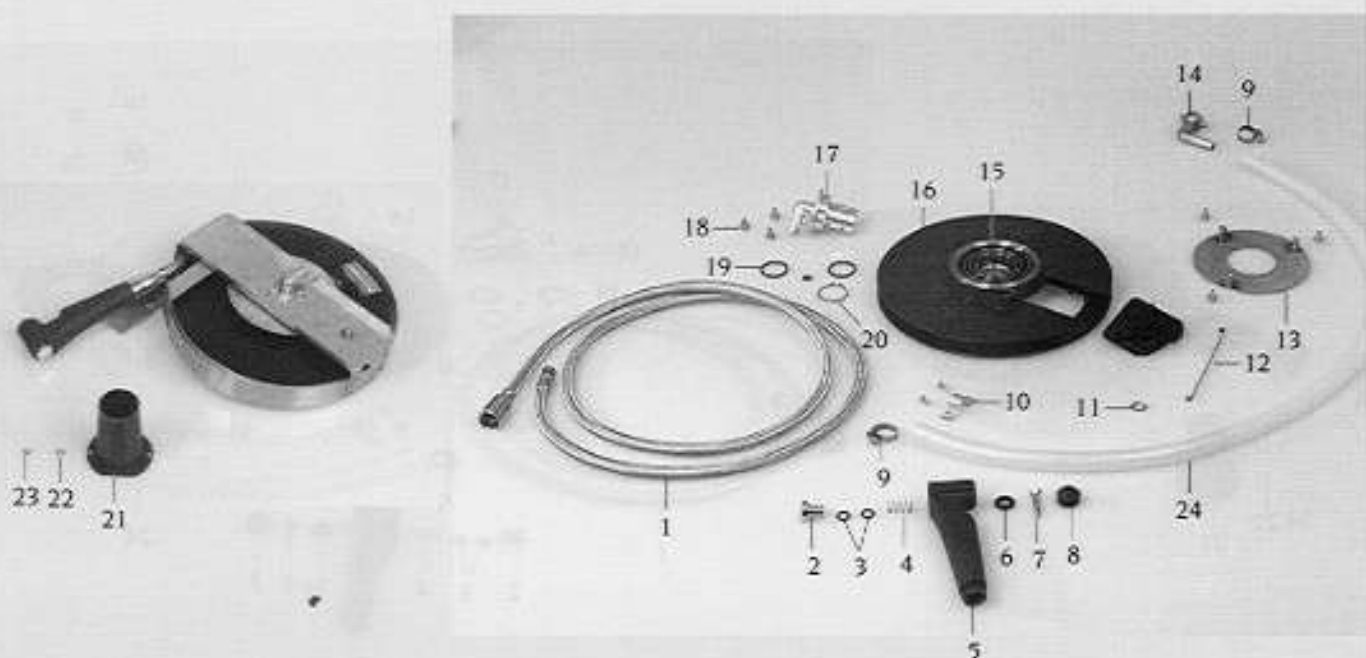

Pos. Pos.	St. Pcs.	Ersatz-Nr. Sp. Part No.	Bezeichnung	Description
-	1	8655.2006	Schlauchroller kpl.	Hand shower roll guide
1	1	2067.0605	Brauseschlauch 1500 mm	Shower hose 1500 mm
-	2	2060.0228	O-Ring für Brauseschlauch	O-ring for shower hose
2	1	2060.1001	Druckknopf für Handbrause	Push-button for hand shower
3	2	5012.0559	O-Ring f. Schlauchbrause d 7x2,5mm	O-ring for hand shower d 7x2,5mm
4	1	2001.0110	Druckfeder f. Schlauchbrause	Compression spring for hand shower
5	1	2060.1000	Handbrause	Hand shower
6	1	5012.0558	O-Ring f. Schlauchbrause d 8x5mm	O-ring for hand shower d 8x5mm
7	1	2060.1003	Steilkegelstift Handbrause	Steep taper pin for hand shower
8	1	2060.1002	Düse f. Handbrause	Nozzle for hand shower
9	2	2066.0205	Schlauchschelle 12-18mm	Hose clamp 12-18mm
10	1	2760.1159	Befestigungsschelle	Fixing clip
-	2	1003.0231	Kerbschraube 3,9x13 mm	Slotted screw 3.9 x 13 mm
11	1	2001.0203	Federmutter d 8mm	Spring nut d 8 mm
12	1	2001.0202	Bügel Feder f. Schlauchroller	Return spring for hose roll guide
13	1	8655.2005	Haltescheibe für Spiralfeder	Locking disc for spiral coiled spring
14	1	2062.0208	Winkelverschraubung G1/2"x10	Elbow screw point G1/2"x10
-	1	5012.0539	Dichtung für Verschraubung G 1/2"	Gasket for G1/2" threaded joint
15	1	2001.0201	Spiralfeder f. Schlauchroller	Spiral coiled spring for hose roll guide
16	1	2060.0150	Schlauchrad für Handbrause	Retractable wheel for hand shower
17	1	2060.0157	Achse für Schlauchroller	Axle for hose roll
18	3	1005.2000	Sperrzahnschraube M 5x8	Interlocking tooth screw M 5x8
19	1	8000.0081	Satz O-Ring	Set O-ring
20	1	1250.0103	Sicherungsring 28mm	Guard ring 28mm
21	1	2060.1200	Aufnahme für Handbrause	Hand shower intake
22	2	1304.0150	Unterlegscheibe A3.2	Washer A3.2
23	2	1103.0120	Sechskantmutter M 3	Hexagonal nut M3

Heißluftheizung Hot Air Heating	Spannung Voltage	Baugruppe Group	Ausgabe Edition	gültig ab Seriennummer Application from Serial.No.
	3 N AC 400V 50Hz	5	5.1.1	C11C93065001

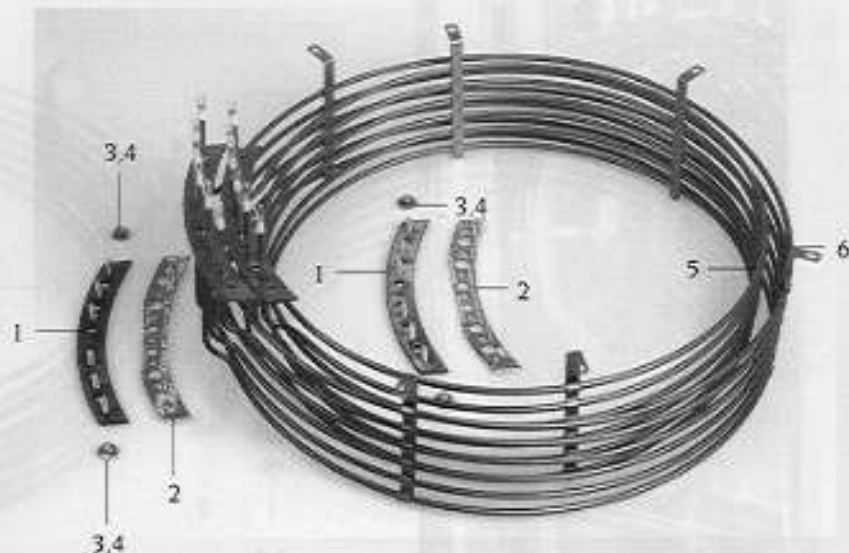

Pos.	St.	Ersatz.Nr.	Bezeichnung	Description
Pos.	Pcs.	Sp. Part No.		
1	2	2150.1005	Flansch Außenseite f. Heizregister	External flange for heating element
2	4	5110.1009	Dichtring f. Heizregister	Seal ring for heating assembly
3	18	1106.0360	Hutmutter M6	Cap nut M6
4	18	1206.0261	Federring B6	Spring washer B6
5	1	3200.1000	Heizregister innen 230V	Inner heating assembly 230V
6	1	3200.1001	Heizregister außen 230V	Outer heating assembly 230V

Garraum Interior Cabinet	Spannung Voltage	Baugruppe Group	Ausgabe Edition	gültig ab Seriennummer Application from Serial.No.
	3 N AC 400V 50Hz	7	7.1.1	C11C93065001

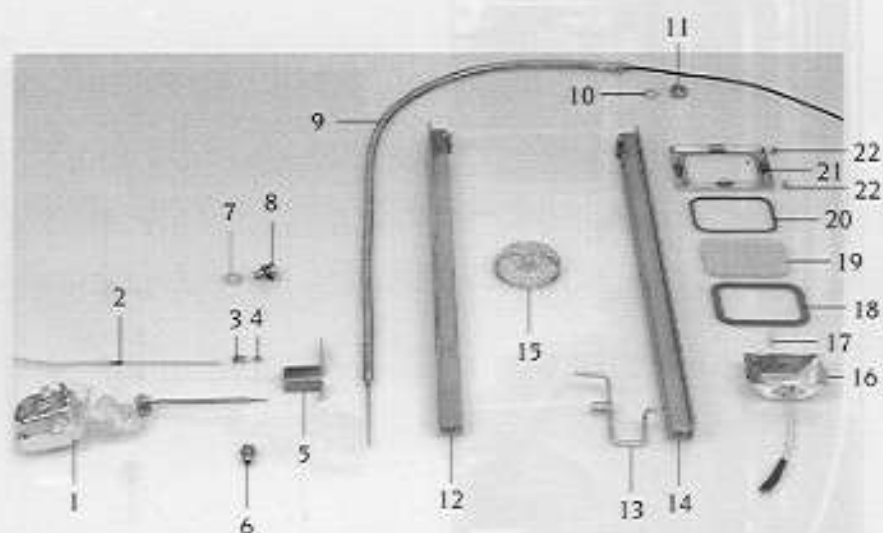

Pos.	St.	Ersatz.Nr.	Bezeichnung	Description
Pos.	Pcs.	Sp. Part No.		
-	-	8516.1024	Luftleitblech CCM/CCC 101	Air baffle CCM/CCC 101
1	1	3014.0322	Sicherheitstemperaturbegrenzer 360°C	Safety temperature limiter 360°C
2	2	3014.0160	Mantelthermoelement Garraum	Sheath thermo element
3	2	3014.0163	Stopfbuchsnippel für Thermoelement	Gasket sleeve with nipple
4	1	3014.0162	Dichtkegel für Thermoelement	Sealing cone for thermo element
5		2720.1073	Thermostathaltewinkel	Holding angle for thermostat
6	1	2035.0110	Zungendüse für Beschwadung	Moistening nozzle
7	2	2043.0203	Haltescheibe für Verschlußbolzen	Holder plate for air baffle
8	2	2043.0201	Verschlußbolzen für Luftleitblech	Locking pin for air baffle
9	1	3035.0701	Einstechfühler	Meat probe sensor
10	1	1315.0105	Kupferdichtung für Einstechfühler	Copper gasket for meat probe sensor
11	1	1112.0110	Sechskantmutter M 10	Hexagonal nut M 10
12	1	8514.1023	Einfahrschiene links	Rail left
13	1	8514.1025	Sperrklinke f. Einfahrschiene rechts	Bolt for oven rack rail right
14	1	8514.1024	Einfahrschiene rechts	Rail right
15	1	2005.0302	Ablaufsieb	Outlet sieve
16	1	8514.1018	Reflektor kpl. f. Garraumbeleuchtung	Reflector unit for interior lighting
17	1	3024.0201	Halogenarräumlampe 10 W/12V/300°C	Halogen bulb 10 W/12V/300°C
18	1	5110.1023	Dichtungsrahmen innen	Internal gasket frame
19	1	5201.1000	Glas f. Garraumbeleuchtung	Glass for interior lamp
20	1	5110.1022	Dichtungsrahmen außen f. Garraumbeleuchtung	External gasket frame
21	1	8514.1017	Andrückrahmen f. Garraumbeleuchtung	Press down frame
22	4	1008.0753	Sechskantschraube M5x8	Hexagonal screw M5x8

Garraum Interior cabinet	Spannung Voltage	Baugruppe Group	Ausgabe Edition	gültig ab Seriennummer Applicable from Serial.No.
	3 N AC 400V 50Hz	7	7.1.2	C11C95057001

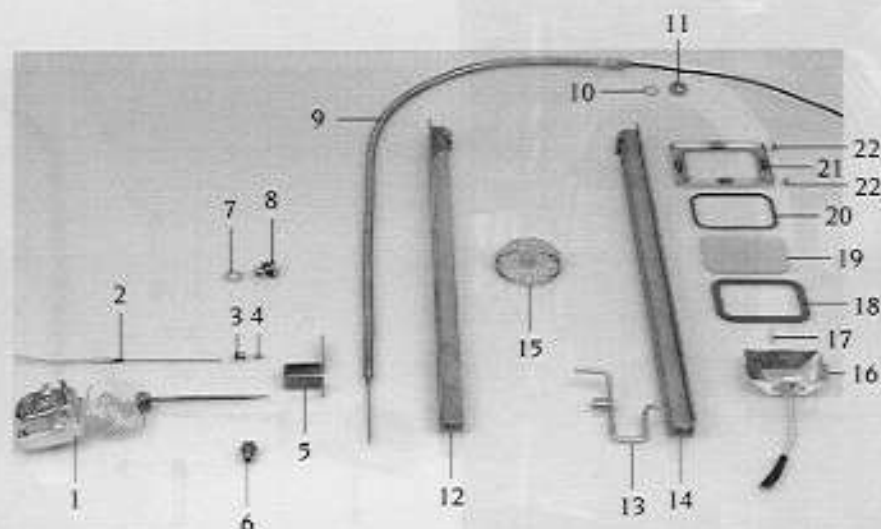

Pos.	St.	Ersatz-Nr.	Bezeichnung	Description
Pos.	Pcs.	Sp. Part No.		
-	-	8516.1024	Luftleitblech Typ 101	Air baffle type 101
-	-	8720.1003	Mantelthermoelement kpl. lang (Pos. 2,3,4)	Sheath thermo element cpl. long (pos. 2,3,4)
1	1	3014.0322	Sicherheitstemperaturbegrenzer 360°C	Safety temperature limiter 360°C
2	1	3014.0160	Mantelthermoelement lang	Sheath thermo element long
3	1	3014.0163	Stopfbuchsnippel für Thermoelement	Gasket sleeve with nipple
4	1	3014.0162	Dichtkegel für Thermoelement	Sealing cone for thermo element
5	1	2720.1073	Thermostathaltewinkel	Holding angle for thermostat
6	1	2035.0110	Zungendüse für Beschwädung	Moistening nozzle
7	2	2043.0203	Haltescheibe für Verschlußbolzen	Holder plate for locking pin
8	2	2043.0201	Verschlußbolzen für Luftleitblech	Locking pin for air baffle
9	1	3035.0701	Einstechfühler	Meat probe sensor
10	1	1315.0105	Kupferdichtring für Einstechfühler	Copper washer for meat probe sensor
11	1	1112.0110	Sechskantmutter M 10	Hexagonal nut M10
12	1	8514.1023	Einfahrschiene links	Rail left
13	1	8514.1025	Sperrklinke f. Einfahrschiene rechts	Bolt for oven rack rail right
14	1	8514.1024	Einfahrschiene rechts	Rail right
15	1	2005.0302	Ablaufsieb	Outlet sieve
16	1	8514.1018	Reflektor kpl. f. Garraumbeleuchtung	Reflector unit for interior lighting
17	1	3024.0201	Halogenarraumlampe 10 W/12V/300°	Halogen bulb 10 W/12V/300°
18	1	5110.1023	Dichtungsrahmen Innen	Internal gasket frame
19	1	5201.1000	Glas f. Garraumbeleuchtung	Glass for interior lamp
20	1	5110.1022	Dichtungsrahmen außen	External gasket frame
21	1	8514.1017	Andrückrahmen f. Garraumbeleuchtung	Press down frame for interior lighting
22	4	1008.0753	Sechskantschraube M 5x8	Hexagonal screw M5x8
23	2	8514.1064	Anschlagwinkel für Trichterblech kpl.	Holding bracket air baffle
-	4	1106.0360	Hutmutter M6 hohe Form	Cap nut M6, high shape
-	4	1206.0261	Federring B6	Spring washer B6
-	4	1306.0120	Unterlegscheibe A6,4	Washer A6,4
-	1	8817.1201	Kabel für Innenbeleuchtung	Cable for interior light
-	1	4001.1248	Porzellanklemme 2 polig	Porcelain connector 2 pin interior light

Sonstiges VariousMiscellaneous Di

Pos. Pos.	Ersatz.Nr. Sp. Part No.	Bezeichnung <small>Description</small>	Description
1	1003.2260	Linsensenk-Blechschrabe HC4,2x16	Raised countersunk head - self-tapping screw HC4,2x16
2	1004.2160	Sechskant Blechschrabe A4,2x16	Hex self-tapping screw A4,2x16
3	1104.0821	Blechmutter B3,9	Climp B3,9
4	1107.0100	Schnellbefestiger d4,0 mm	Quick fastener d4.0 mm
5	1107.0101	Schnellbefestiger d5,0mm	Quick fastener d5.0mm
6	1107.0102	Schnellbefestiger d12mm	Quick fastener d12mm
7	1107.0103	Schnellbefestiger d3mm	Quick fastener d3mm
8	1311.2260	Schraubenrosette 5x12,5	Rosette 5x12,5
9	1901.0042	Blechklammer für Außenmantel	Clamp for exterior cabinet
10	1901.0044	Blechklammer für Deckel bis 05/95	Clamp for cover up to 05/95
11	2001.0042	Loctite Schraubensicherung 10ml	Screw locking, heat resistant 10ml
12	2005.0500	Lenkrolle d/125-10.3 ohne Feststeller	Castor d/125-10.3 without stopper
13	2005.0600	Lenkrolle d/125-10.3 mit Feststeller	Castor d/125-10.3 with stopper
14	3016.1409	Magnet rund Tischgeräte	Magnet round table models
15	3016.1412	Magnet eckig Standgeräte	Magnet angular floor models
16	4002.0100	Flachsteckhülse 2,5x6,3	Cable shoes 2,5x6,3
17	4004.0100	Aderendhülse 1,0mm ²	Wire end sleeve 1.0mm ²
18	4004.0101	Aderendhülse 1,5mm ²	Wire end sleeve 1.5mm ²
19	4004.0102	Aderendhülse 2,5mm ²	Wire end sleeve 2.5mm ²
20	4004.0103	Aderendhülse 4mm ²	Wire end sleeve 4mm ²
21	4004.0104	Aderendhülse 6mm ²	Wire end sleeve 6mm ²
22	4004.0105	Aderendhülse 10mm ²	Wire end sleeve 10mm ²
23	4004.0106	Aderendhülse 16mm ²	Wire end sleeve 16mm ²
24	4004.0114	Aderendhülse 0,75mm ²	Wire end sleeve 0.75mm ²
25	4005.0101	Kabelbinder 145mm lang	Cable strap 145mm long
26	4005.0102	Kabelbinder 100mm lang	Cable strap 100mm long
27	5003.0300	Isolierung Dampfgenerator 1250x1250mm	Insulation steam generator 1250x1250mm
28	5006.0200	Tube Silikon E41	Silicone (tube) E41
29	5006.0500	Kleber Isolierung Dampfgenerator 310ml	Adhesive isulation steam generator 310ml
30	6004.0100	Handdruck Sprühpistole	Spray-pistol
31	6004.0101	Verlängerung Handdruck Sprühpistole	Lengthening piece for spray-pistol
32	6004.0102	Dichtung Handdruck Sprühpistole	Gasket for spray-pistol
33	6004.0203	Entkalker-Fußpumpe	Descaler foot pump
34	6006.0101	RATIONAL Spezialreiniger	RATIONAL special cleaning agent
35	6006.0110	RATIONAL Entkalker	RATIONAL descaler
36	6021.1029	Griff für Hordengestellwagen	Handle for mobile oven rack
37	9003.0202	Unimoly plus, 180 °C	Unimoly plus, 180 °C
38	9006.0850	Metallwaschcreme	Stainless steel cleaning paste

Motor und Lüfterrad Motor and Fan Wheel	Spannung Voltage	Baugruppe Group	Baugruppe Group	gültig ab Seriennummer Application from Serial.No.
	3 N AC 400V 50Hz	6	6.1.1	C11C93065001

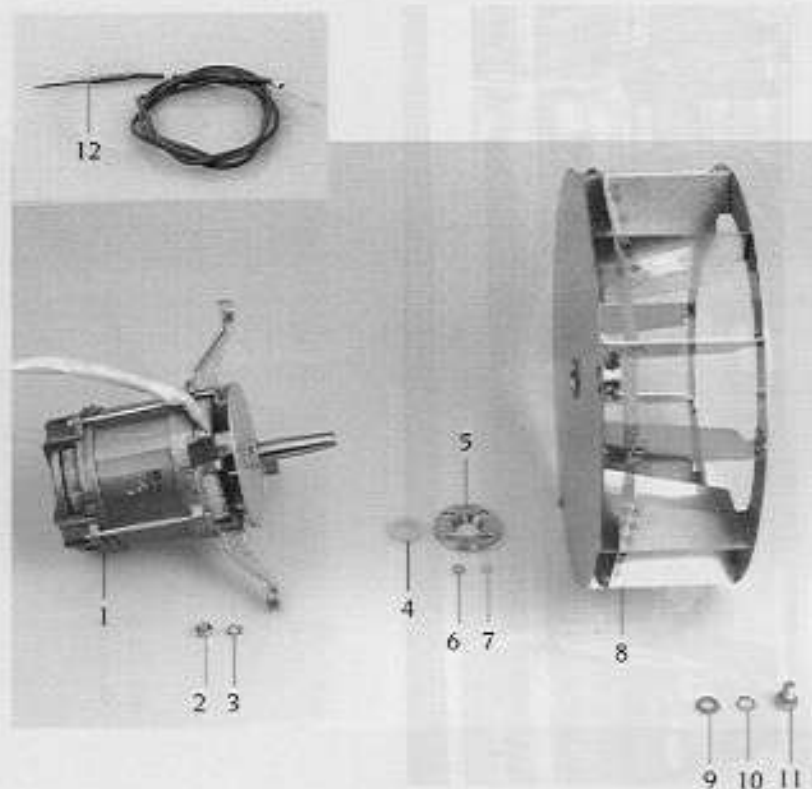

Pos.	St.	Ersatz.Nr.	Bezeichnung	Description
Pos.	Pcs.	Sp. Part No.		
1	1	3100.1000	Lüftermotor	Fan motor
2	4	1108.0260	Sechskantmutter M 8	Hexagonal nut M8
3	4	1208.0160	Zahnscheibe d 8,4	Toothed disc d 8.4
4	1	5001.0207	Motorwellendichtung	Motor shaft gasket
5	1	2016.0876	Dichtungsflansch für Motorwelle	Gasket flange for motor shaft
6	4	1106.0220	Sechskantmutter M6 flach	Hexagonal nut M6 flat
7	4	1315.0101	Kupferdichtung 6x10	Copper gasket 6x10
8	1	2012.0900	Lüfterrad	Fan wheel
9	1	1210.0160	Unterlegscheibe A 10,5	Washer A 10.5
10	1	1310.0160	Zahnscheibe A 10,5	Toothed disc A 10.5
11	1	1010.0760	Sechskantschraube M 10x16	Hexagonal screw M10x16
12	1	3014.0165	Mantelthermoelement	Sheath thermo element
-	1	2066.0201	Schlauchschelle 110-130mm	Hose clamp 110-130mm

Motor und Lüfterrad Motor and fan wheel	Spannung Voltage	Baugruppe Group	Ausgabe Edition	gültig ab Seriennummer Applicable from Serial.No.
	3 N AC 400V 50Hz	6	6.1.2	C11C95057001

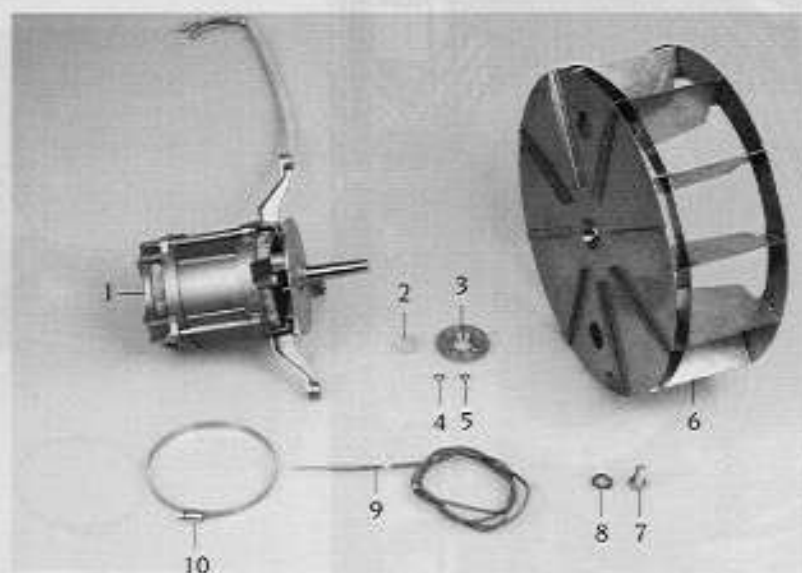
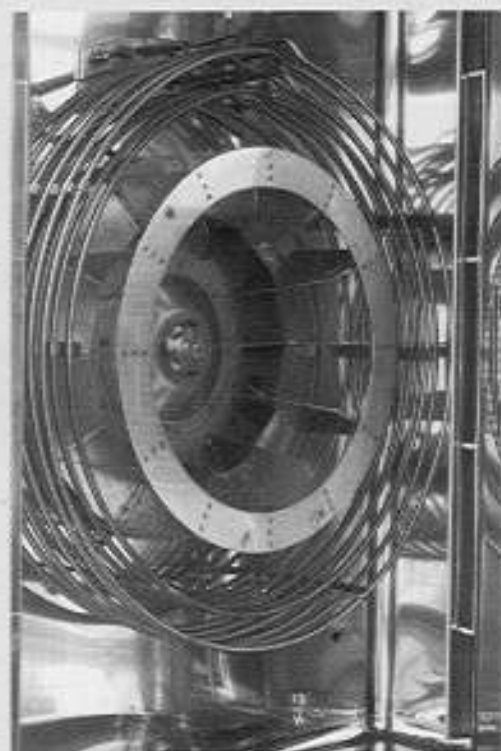

Pos.	St.	Ersatz.Nr.	Bezeichnung	Description
Pos.	Pcs.	Sp. Part No.		
1	1	3100.1000	Lüftermotor	Fan motor
-	4	1108.0260	Sechskantmutter M 8	Hexagonal nut M8
-	4	1208.0260	Federring B8	Spring washer B8
-	1	8514.1202	Halteplatte für Lüftermotor	Fan motor holding plate
-	4	1315.0101	Kupferdichtung 6x10 mm	Copper gasket 6x10 mm
2	1	5001.0207	Motorwellendichtung	Motor shaft gasket type
3	1	2016.0876	Dichtungsflansch für Motorwelle	Gasket flange for engine shaft
4	4	1306.0120	Unterlegscheibe A6.4	Washer A6.4
5	4	1106.0220	Sechskantmutter M6 flach	Hexagonal nut M6 flat
6	1	2012.0502	Lüfterrad	Fan wheel
7	1	1010.0762	Sechskantschraube M 10x20	Hexagonal screw M10x20
8	1	1328.0102	Sperrkantscheibe A10,2	Safety washer A10,2
9	1	3014.0161	Mantelthermoelement kurz	Sheath thermo element short
10	1	2066.0201	Schlauchscheile 110-130mm	Hose clamp 110-130mm

Ablöschkasten Quenching box	Spannung Voltage	Baugruppe Group	Ausgabe Edition	gültig ab Seriennummer Applicable from Serial.No.
	3 N AC 400V 50Hz	10	10.1.2	C11C95057001

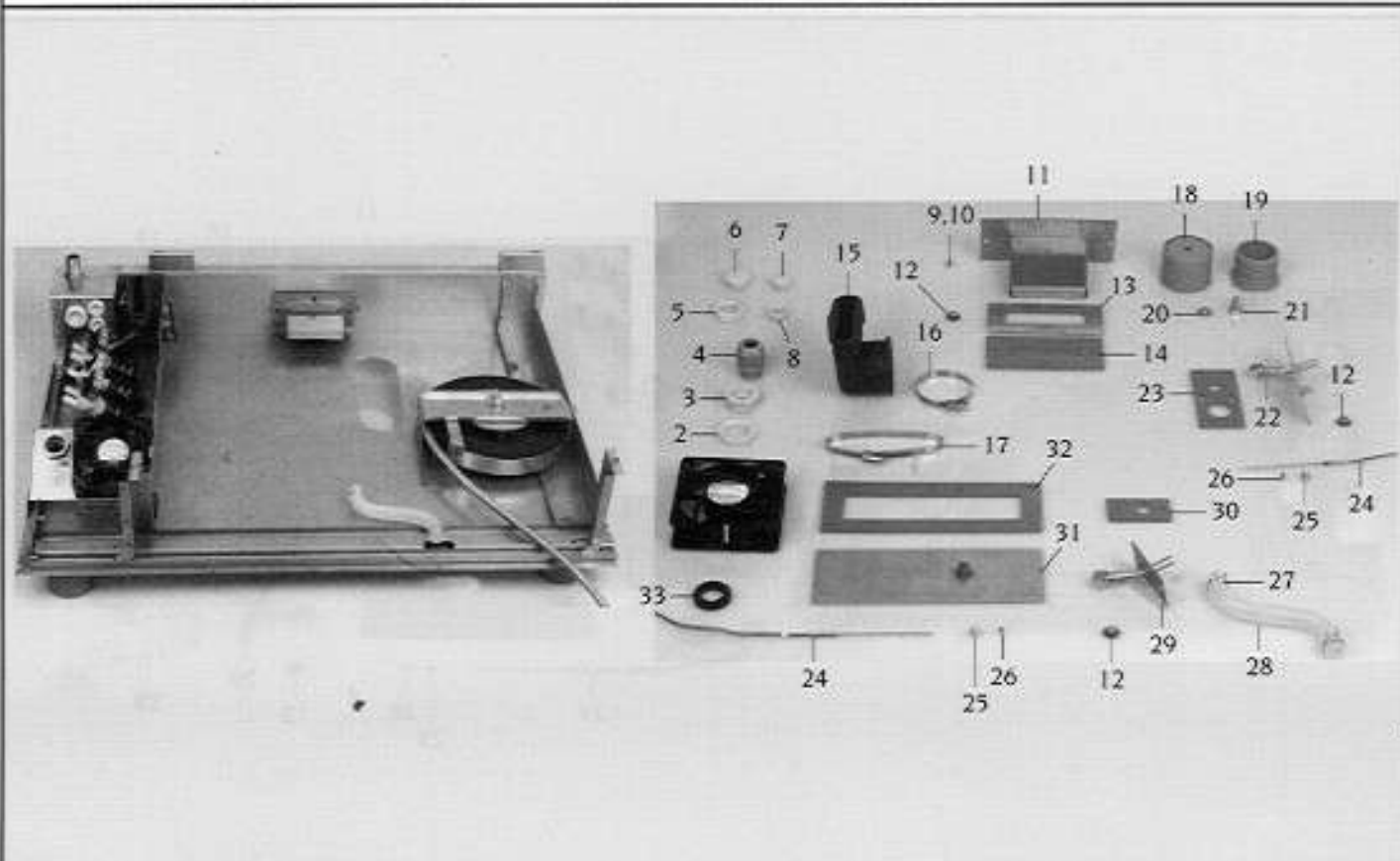

Pos. St.	Ersatz.Nr.	Bezeichnung	Description
Pos. Pcs.	Sp. Part No.		
-	2067.0050	Silikon Schlauch 1m	Silicone hose 1m
-	8720.1003	Mantelthermoelement kpl. lang (Pos. 24-26)	Sheath thermo element cpl. long (pos. 24-26)
1	3101.1008	Kühlflüster	Cooling motor
2	4007.0206	Sechskantmutter für PG 29	Hex screw for PG 29
3	4007.0306	Reduzierstück PG 29/21	Reducing socket PG 29/21
4	4007.0305	Kabelverschraubung PG 21	Screw-type conduit fitting PG 21
5	4007.0526	Sechskantmutter für PG 21	Hex screw for PG 21
6	4007.0615	Stopfen PG 21	Plug PG 21
7	4007.0614	Stopfen PG 13,5	Plug PG 13,5
8	4007.0521	Sechskantmutter für PG 13,5	Hex screw for PG 13,5
9	1004.2164	Sechskant Blechschraube A4,2x16	Hex self-tapping screw A4,2x16
10	1304.0160	Unterlegscheibe A4,3	Washer A4,3
11	8666.1200	Überlaufkanal geschweißt	Overflow box
12	1106.0801	Sechskant-Combi-Mutter M 6	Hexagonal combination nut M6
13	2715.1203	Flansch hinten	Flange for overflow box
14	5110.1204	Dichtung Überlaufkanal	Gasket for flange overflow box
15	2118.1202	Manschette Entlüftungsrohr unten	Rubber form piece venting pipe up
16	2066.0505	Schlauchschele 70-90mm	Hose clamp 70-90mm
17	2066.0524	Schlauchschele 90-110mm	Hose clamp 90-110mm
18	2039.0112	Fußoberteil	Upper part of pedestal
19	2039.0113	Fußunterteil	Lower part of pedestal
20	2750.1020	Unterlegscheibe A10,5	Washer A10,5
21	1010.0760	Sechskantschraube M 10x16	Hexagonal screw M10x16
22	8666.1203	Ablöschdüse D1 kpl.	Quenching nozzle D1 cpl.
23	5110.1201	Dichtung Ablöschdüse D1	Gasket for quenching nozzle D1
24	3014.0160	Mantelthermoelement lang	Sheath thermo element long
25	3014.0163	Stopfbuchsniessel für Thermoelement	Gasket sleeve with nipple
26	3014.0162	Dichtkegel für Thermoelement	Sealing cone for thermo element
27	2066.0525	Schlauchklemme 22,1mm	Hose clamp 22,1mm
28	2112.1025	Form-Entleerschlauch für Tropfwanne	Emptying hose for drip pan
29	8666.1204	Ablöschdüse D2 kpl.	Quenching nozzle D2 cpl.
30	5110.1202	Dichtung Ablöschdüse D2	Gasket for quenching nozzle D2
31	8666.1205	Flansch vorne	Flange quenching D2
32	5110.1203	Dichtung für Revisionsflansch	Gasket revision flange
33	2022.0105	Durchführungsstülle d 26mm	Lead-in grommet d 26 mm

Ablöschkasten Quenching box	Spannung Voltage	Baugruppe Group	Ausgabe Edition	gültig ab Seriennummer Applicable from Serial.No.
	3 N AC 400V 50Hz	10	10.2.1	C11C95057001

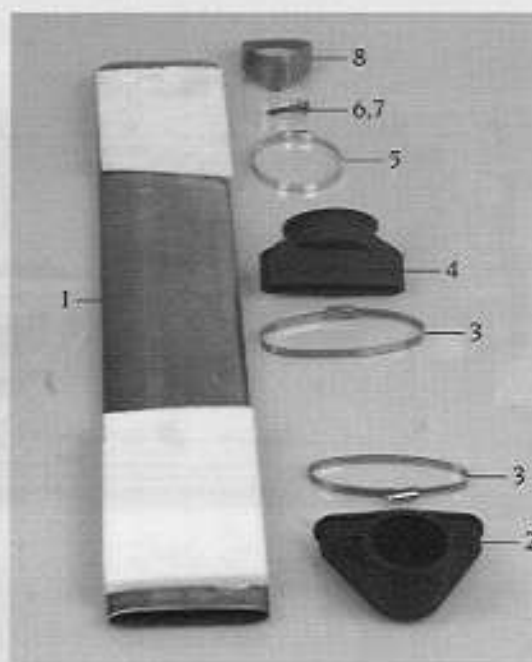
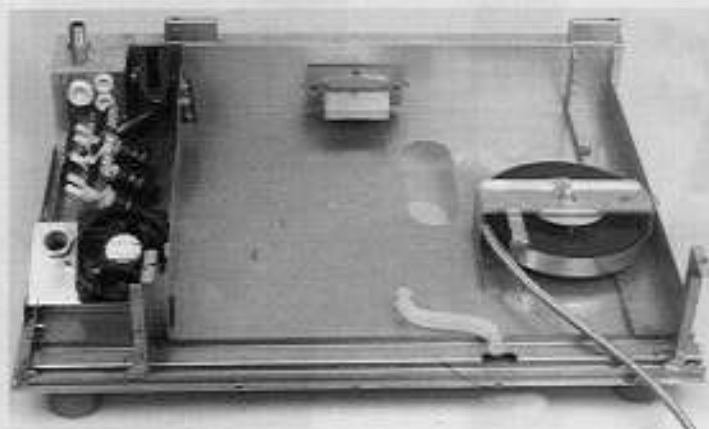

Pos.	St.	Ersatz.Nr.	Bezeichnung	Description
Pos.	Pcs.	Sp. Part No.		
1	1	2910.1204	Entlüftungsrohr	Venting pipe quenching chamber
2	1	2118.1202	Manschette Entlüftungsrohr unten	Rubber form piece venting pipe up
3	2	2066.0524	Schlauchselle 90-110	Hose clamp 90-110
4	1	2118.1201	Manschette Entlüftungsrohr oben	Rubber form piece venting pipe down
-	1	8455.1208	Glockenhalter	Vent cover bracket
5	1	2066.0505	Schlauchselle 70-90mm	Hose clamp 70-90mm
-	1	2760.1253	Lochscheibe d64mm	Protection plate d64mm
6	1	1006.0764	Sechskantschraube M 6x25	Hexagonal screw M 6x25
7	1	1306.0120	Unterlegscheibe A6,4	Washer A6.4
8	1	8455.1215	Entlüftungsstutzen	Venting stud

Dampfgenerator Steam Generator	Spannung Voltage	Baugruppe Group	Ausgabe Edition	gültig ab Seriennummer Application from Serial.No.
	3 N AC 400V 50Hz	4	4.1.1	C11C93065001

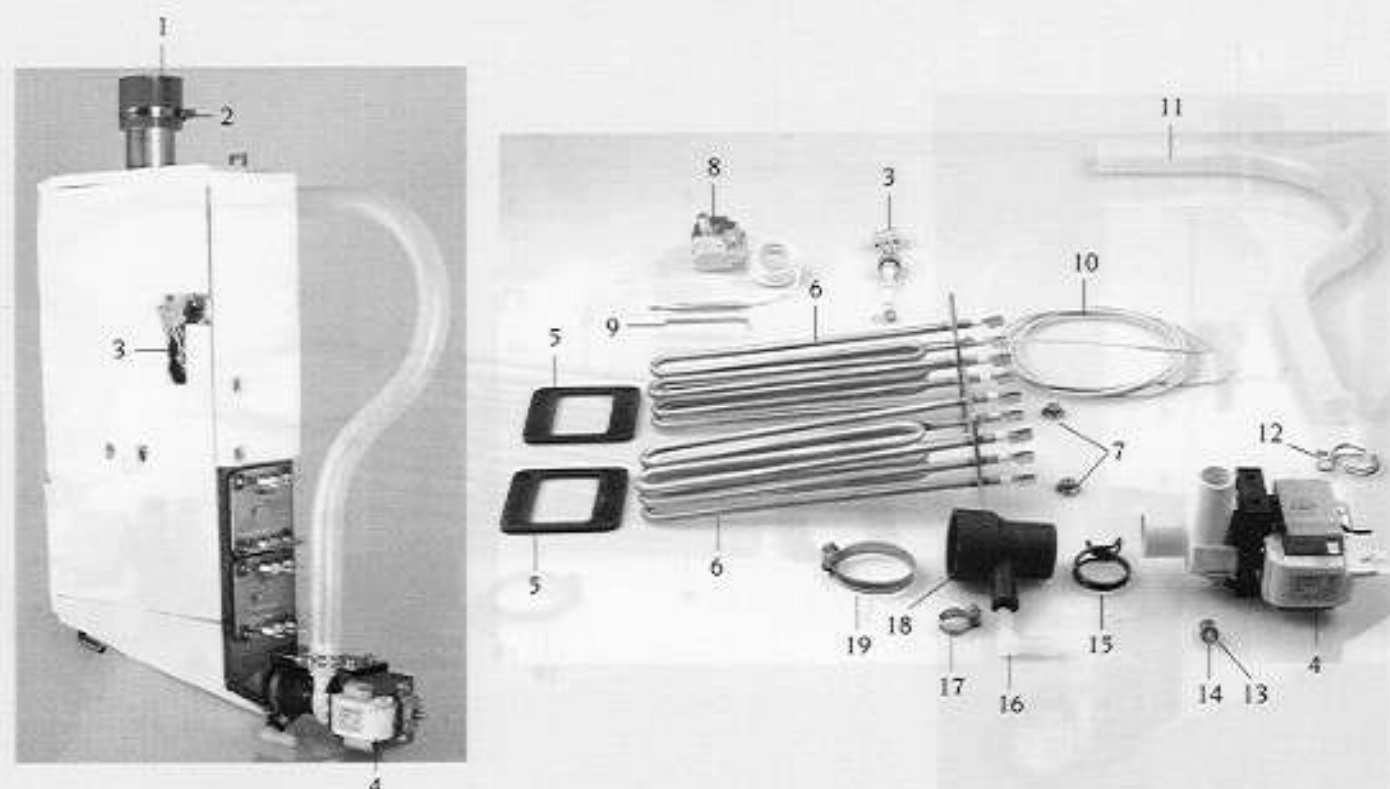

Pos. St.	Ersatz.Nr.	Bezeichnung	Description	
Pos. Pcs.	Sp. Part No.			
-	1	8350.1000	Dampfgenerator kpl.	Steam generator unit
1	1	2112.1006	Dampfschlauch 50x7mm	Steam hose 50x7mm
2	2	2066.0503	Schlauchschelle 25-40mm	Hose clamp 25-40mm
3	1	3002.0402	Füllstandselektrode 90mm.	Filling level electrode 90 mm
4	1	3002.1000	Entleerungspumpe 200-240V 50/60Hz	Emptying pump 200-240V 50/60Hz
5	2	5110.1003	Dichtung f. Tauchheizkörper	Gasket for heating element
6	2	3201.1000	Tauchheizkörper 3x3 kw/230V	Heating element 3x3 kw/230V
7	8	1106.0801	Sechskant-Combi-Mutter M 6	Hexagonal combination nut M6
8	1	3014.0300	Trockengehschutz 125 °	Dry up protector 125 °
9	1	2740.1040	Klemmblech Dampfgenerator	Clamping plate for steam generator
10	1	3014.0165	Thermoelement Dampfgenerator	Thermo element steam generator
11	1	2112.1004	Entleerschlauch 22x4x635	Emptying hose 22x4x635
12	2	2066.0522	Schlauchklemme 31,3mm	Hose clamp 31,3mm
13	2	1306.0120	Unterlegscheibe A6,4	Washer A6,4
14	2	1006.0621	Innensechskantschraube M 6x12	Allen screw M6x12
15	1	2066.0519	Schlauchklemme 35,6mm	Hose clamp 35,6mm
16	1	2062.0301	Winkelstück Kunststoff WS 10	Elbow piece plastic WS 10
17	2	2066.0205	Schlauchschelle 12-18mm	Hose clamp 12-18mm
18	1	2118.1000	Pumpenanschlußstutzen	Pump connection spout
19	1	2066.0507	Schlauchschelle 32-50mm	Hose clamp 32-50mm

Dampfgenerator Steam generator	Spannung Voltage	Baugruppe Group	Ausgabe Edition	gültig ab Seriennummer Applicable from Serial.No.
	3 N AC 400V 50Hz	4	4.1.2	C11C95057001

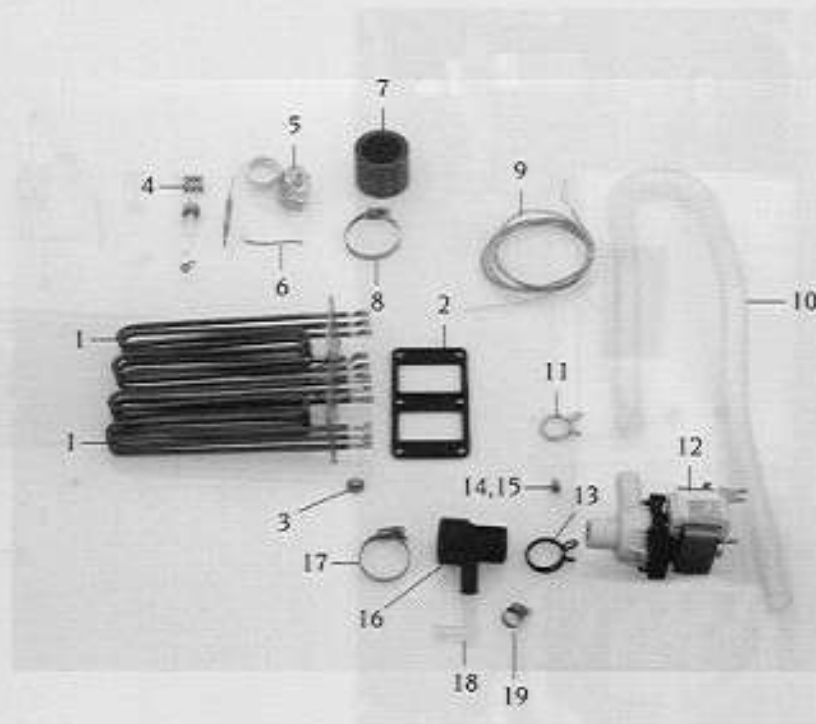
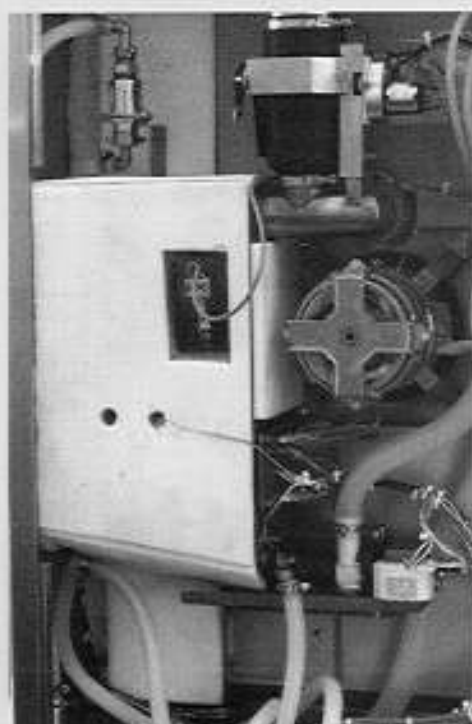

Pos.	St.	Ersatz.Nr.	Bezeichnung	Description
Pos.	Pcs.	Sp. Part No.		
-	1	8720.1204	Dampfgenerator kpl. 230V/50Hz	Steam generator cpl. 230V/50Hz
-	1	8720.1200	Dampfgenerator isoliert	Steam generator type insulated
-	1	5212.1200	Isolierung für Dampfgenerator	Insulation for steam generator
1	2	3201.1200	Tauchheizkörper 3x3 kw 230V	Heating element 3x3 kw 230V
2	1	5110.1200	Dichtung f. Tauchheizkörper	Gasket for heating element
3	6	1106.0801	Sechskant-Combi-Mutter M 6	Hexagonal combination nut M6
4	1	3002.0402	Füllstandselektrode 90mm	Filling level electrode 90mm
5	1	3014.0300	Trockengehschutz 125°C	Dry up protector 125°C
6	1	2740.1040	Klemmblech Dampfgenerator	Clamping plate for steam generator
7	1	2112.1006	Dampfschlauch 50x7mm	Steam hose 50x7mm
8	1	2066.0300	Schlauchscheile 50-70mm	Hose clamp 50-70mm
9	2	3014.0165	Thermoelement Dampfgenerator	Thermo element steam generator
10	1	2112.1200	Entleerschlauch	Emptying hose
11	1	2066.0522	Schlauchklemme 31,3mm	Hose clamp 31,3mm
12	1	3002.1000	Entleerpumpe 200-240V 50/60Hz	Emptying pump 200-240V 50/60Hz
13	2	2066.0519	Schlauchklemme 35,6mm	Hose clamp 35,6mm
14	2	1006.0621	Innensechskantschraube M 6x12	Allen screw M6x12
15	2	1306.0120	Unterlegscheibe A6,4	Washer A6,4
16	1	2118.1000	Pumpenanschlußstutzen	Pump connection spout
17	1	2066.0507	Schlauchscheile 32-50mm	Hose clamp 32-50mm
18	1	2062.0301	Winkelstück Kunststoff WS 10	Angle piece plastic WS 10
19	2	2066.0205	Schlauchscheile 12-18mm	Hose clamp 12-18mm

Wasseranschluß Water supply	Spannung Voltage	Baugruppe Group	Ausgabe Edition	gültig ab Seriennummer Applicable from Serial.No.
	3 N AC 400V 50Hz	9	9.1.2	C11C95057001

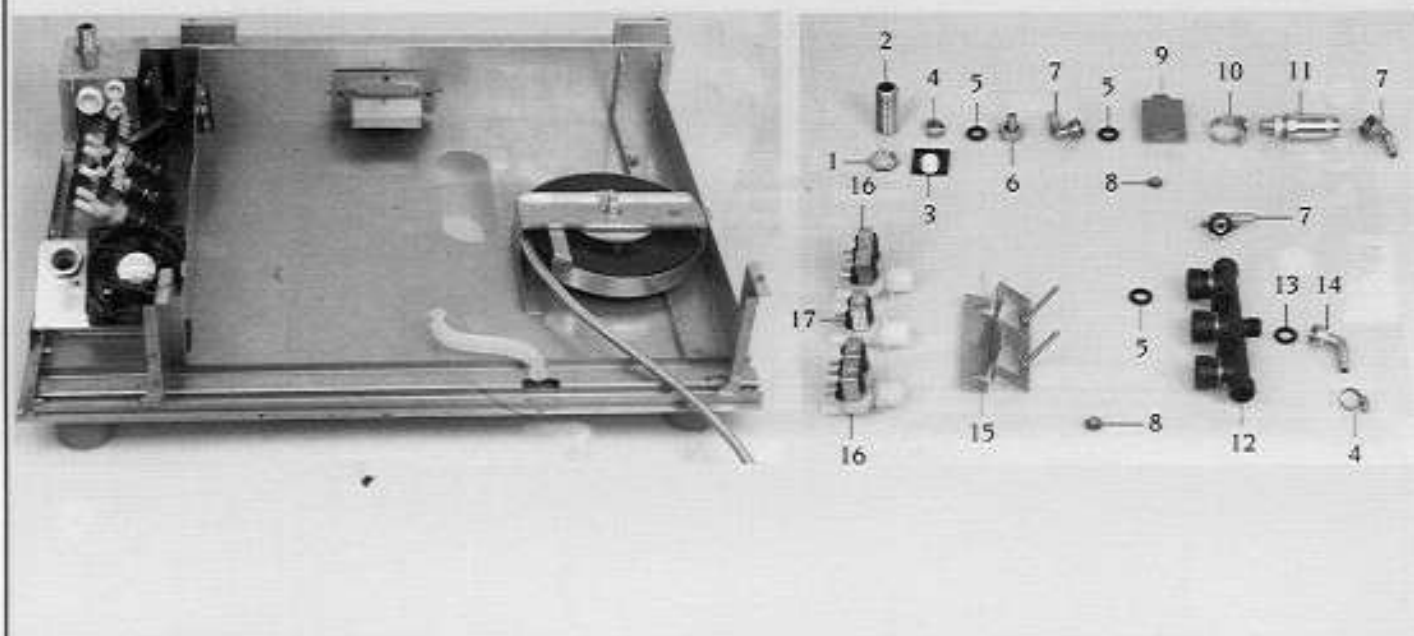

Pos. Pos.	St. Pcs.	Ersatz.Nr. Sp. Part No.	Bezeichnung	Description
-	-	2067.0050	Silikonschlauch 1m	Silicone hose 1m
1	2	2062.0313	Kontermutter G 3/4	Lock-nut G 3/4
2	1	1500.1582	Gewindenippel G3/4"	Thread nipple G3/4"
3	1	1900.0202	Wasserfilter grob	Water filter coarse
4	9	2066.0205	Schlauchschelle 12-18mm	Hose clamp 12-18mm
5	7	5110.1024	Dichtung für Verschraubung G 3/4"	Gasket for G3/4" threaded joint
6	1	2062.0314	Geradeverschraubung G 3/4	Straight threaded joint G 3/4
7	3	2062.0203	Winkelverschraubung G 3/4x10	Elbow screw point G 3/4x10
8	4	1106.0801	Sechskant-Combi-Mutter M 6	Hexagonal combination nut M6
9	1	2717.1200	Haltewinkel für Armaturenkombination	Mounting bracket for double check valve
10	1	2066.0503	Schlauchschelle 25-40mm	Hose clamp 25-40mm
11	1	2069.0103	Armaturenkombination	Valve unit with non-return valve
12	1	8664.1007	Wasserverteiler	Water distribution unit
13	1	5012.0539	Dichtung für Verschraubung G 1/2"	Gasket for G1/2" threaded joint
14	1	2062.0208	Winkelverschraubung G1/2"x10	Elbow screw point G1/2"x10
15	1	8664.1211	Haltehalter für Wasserverteiler	Holding bracket for water manifold
16	2	3002.0330	Doppelmagnetventil kpl. 220-240V 50Hz	Double solenoid valve unit 220-240V 50Hz
17	1	3002.0331	Einfachmagnetventil kpl. 220-240V 50Hz	Single solenoid valve unit 220-240V 50Hz